

# Height Adjustable Kitchen Systems







# CONTENTS

---

ABOUT GRANBERG	4
LIFTING SYSTEMS FOR WALL CABINETS	6
VERTI 840 - Vertical lifting system	8
InDIAGO 510 - Diagonal lifting system	14
DIAGO 504 - Diagonal lifting system fittings	20
LIFTING SYSTEMS FOR KITCHEN WORKTOPS	26
BASELIFT 6300 / 6310 - Straight worktop lift	28
BASELIFT Corner 6301 / 6311 - Corner worktop lift, 45° front, 90° wall	36
BASELIFT Corner 6302 / 6312 - Corner worktop lift, 45° front, 45° wall	44
BASELIFT Corner 6303 / 6313 - Corner worktop lift, 90° front, 90° wall	52
SIDELIFT 6400 - Straight worktop lift with motors on the sides	60
MANULIFT 6350 - Manually adjustable kitchen worktop, cranked winding handle	68
MANULIFT 6380 - Manually adjustable kitchen worktop	74
LIFTING SYSTEMS FOR KITCHEN ISLANDS	
CENTERLIFT 960 - Kitchen island with space for knees	82
CENTERLIFT 6490 - Kitchen island with cabinets and space for knees	88
ERGOSTEEL	
Trendline Inset sinks	96
Inset sinks	112
Sit-on sinks	116
Sink accessories	119
Mixer taps	120
OTHER	
Mini-cabinet on wheels	121
UNILIFT 870 - Kitchen appliance lift	122

**The story began as early as 1870** in Ringarum, Sweden, when Otto Granberg built his first chairs. He sold these chairs at the local market. Business went well and Otto's joinery began mass-producing furniture. The factory soon relocated to Norrköping and expanded their range with windows, doors and staircases. After almost 30 years, Otto's son, Frans, took over the company. He followed in his father's footsteps, but also produced school furniture and interior joinery products. Just over thirty years later, Frans handed over the company to his sons, Nils, Bängt, Oscar and Erik. They continued to run the company the way their father and grandfather had.

Granberg quickly became known for the lifetime guarantee of its products. The quality was high and if anything were to break, the sons ensured it was repaired or replaced. A promise that still applies to this day. Personal service and reliable products. 90 years after Otto began making chairs, the company changed direction and Granberg's modern history began in 1960. The company started to develop products for the disabled and today is a world leader within this sector.



**Quality** has been an important part of our brand ever since Otto Granberg founded our company back in 1870. As a family business we are proud of the products we create. We therefore only supply quality products that we know well and with which we have been working for many years. We always provide a 2 year warranty for our products in order to make our customers feel even more secure.

**For your safety**, we work solely with CE marked lifting systems that have undergone risk analyses and tests. Our lifting systems are based on proven technology and have a built-in safety system that stops the moving parts if anything is in the way.







**SINCE 1870**

**GRANBERG**

# Lifting systems for wall cabinets

## Product overview

Our lifting systems for wall cabinets are designed to be mounted in existing kitchens or supplemented with cabinets from any kitchen supplier. Choose between a vertical or diagonal lifting system that is mounted inside the cabinet or a diagonal lift that lowers the entire cabinet.

The lifting systems are based on proven technology and have built-in safety systems that stop the moving parts if something gets in the way.

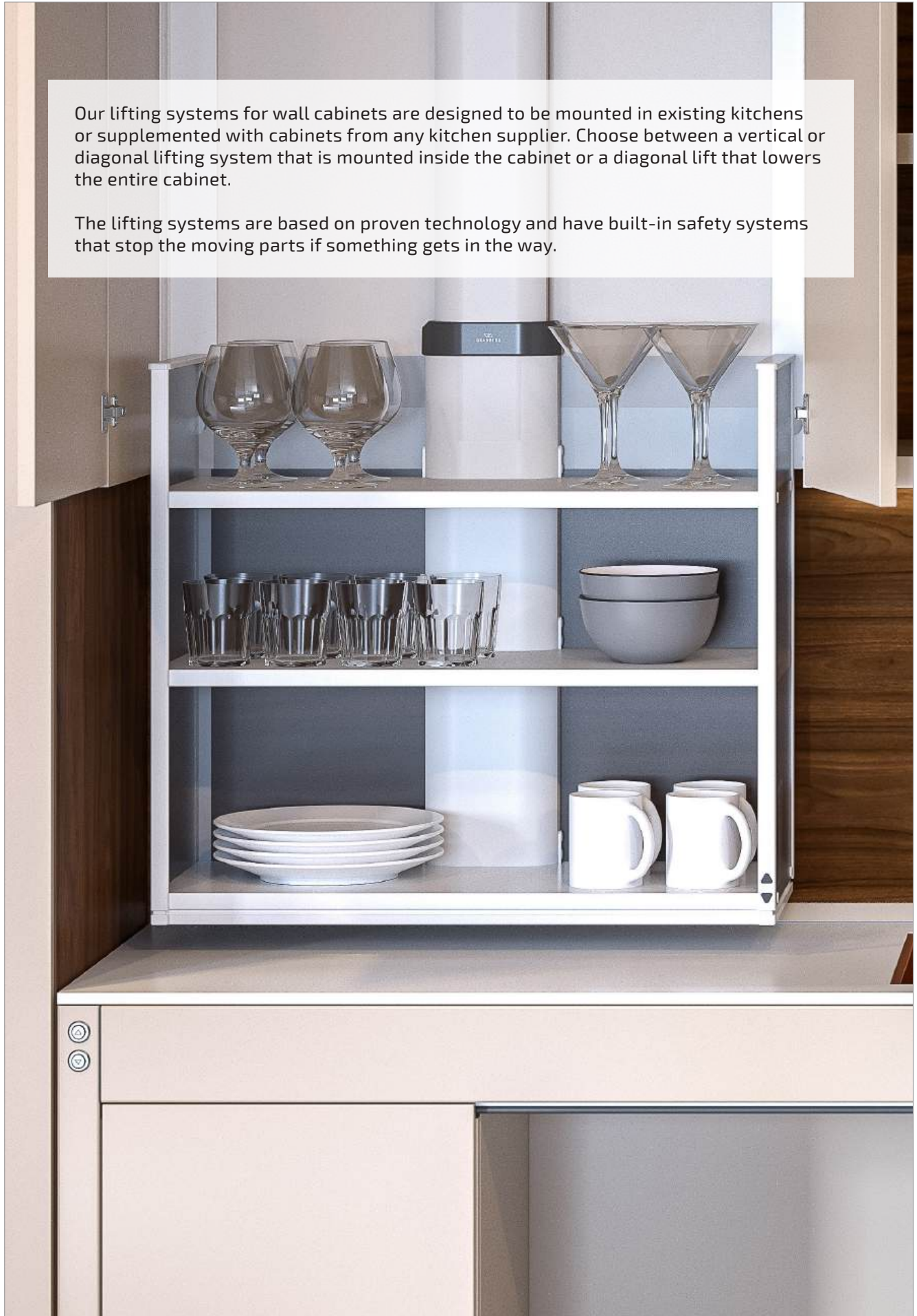



## VERTI 840

- Lowers the shelf unit vertically down to the top board
- When lowered, there is free space on the work top in front of the shelves
- Installed in a new or existing cabinet from which the bottom has been removed



## InDIAGO 510

- Lowers the cabinet unit diagonally downwards and forwards to the front edge of the top board
- Easy to reach the contents since the unit moves forward as it is lowered
- When lowered, the cabinet unit passes in front of the mixer tap
- Easily mounted in new or existing cabinets without the bottom having to be removed. Strip lighting and light ramps are not affected



## DIAGO 504

- Lowers one or more cabinets diagonally downwards and forwards to the front edge of the top board
- Easy to reach the contents since the cabinet comes forward when lowered
- Takes up no space in the cabinet (mounted behind the cabinet)



# VERTI 840

Vertical lifting system for wall cabinets

VERTI is an electric height-adjustable lifting system that lowers the cabinet shelves quickly and silently down to the worktop. The contents of the cabinet are accessible without having to open the doors. When lowered, there is free space on the worktop in front of the shelves. The movement can be stopped at any height.

The lift takes up little space and can easily be mounted in existing or new cabinets without them having to protrude further from the wall.

Fits wall cabinets that are 70 cm high or taller. The lift is available in two different depths and in a wide range of widths to fit cabinets that are 40-100 cm wide.

The lift is equipped with side sheets made from a translucent acrylic material and features a reliable security system that guarantees safe operation without the risk of injury.



The contents are easy to reach when the shelves are lowered. Can be positioned over a worktop with an open front which provides space for knees.





VERTI is suitable for use over a work surface since after being lowered, there is still space at the front of the worktop.



VERTI is mounted inside the wall cabinet and is fully concealed when in the raised position.



### Functions and advantages

- Lowers the shelf unit vertically down to the top board
- When lowered, there is free space on the worktop in front of the shelves
- Installed in a new or existing cabinet from which the bottom has been removed
- Safety plate stops the lowering if it comes in contact with any object on the underlying work surface
- Fits cabinets with width 40-100 cm

### Standard equipment

- Control button
- Safety switch under the bottom shelf
- Full sides – CRYLON Soft tone translucent acrylic sheet

### Recommended additional options

- Lighting

### Useful information

- Leaves a 22-mm gap from wall (space for tiling)
- Model 840KA fits cabinets with an inner depth of 267-311 mm. The shelf depth is 240 mm
- Model 840KB fits cabinets with an inner depth of 312 mm or more. The shelf depth is 285 mm
- For cabinets taller than 700 mm, a fixed shelf is mounted above the lift
- Electronics and motor system "Plug and Play"





### Specifications

<b>Lift model</b>	Vertical lifting system for wall cabinets
<b>Height adjustment</b>	Motorised, steplessly adjustable 485 mm downwards
<b>Speed</b>	41 mm / Sec.
<b>Manoeuvring</b>	Wired button or remote control
<b>Safety</b>	Safety plate under the bottom shelf. If anything touches the plate, the lift stops.
<b>Electricity connection</b>	Plug for 220 – 230V / 50-60Hz/5A
<b>Lifting power</b>	60 kg
<b>IP Class</b>	IP20
<b>Height</b>	680 mm
<b>Fits cabinets with width</b>	400-1000 mm
<b>Fits cabinets with height</b>	700 mm or higher (for heights over 700 mm, a fixed shelf is mounted above the lift)
<b>Fits cabinets with inner depth</b>	VERTI 840KA: 267 - 311 mm VERTI 840KB: From 312 mm
<b>Fits cabinet frames with side thickness</b>	16-20 mm
<b>Material specifications</b>	Shelves: White melamine (19mm) Safety plate: 12 mm MDF Sides: Crylon Softone Metal parts: Powder-lacquered (White RAL 9003). Sliding rail: Aluminium
<b>Warranty</b>	2 year
	<b>CE</b>

### Measurement data

(mm)

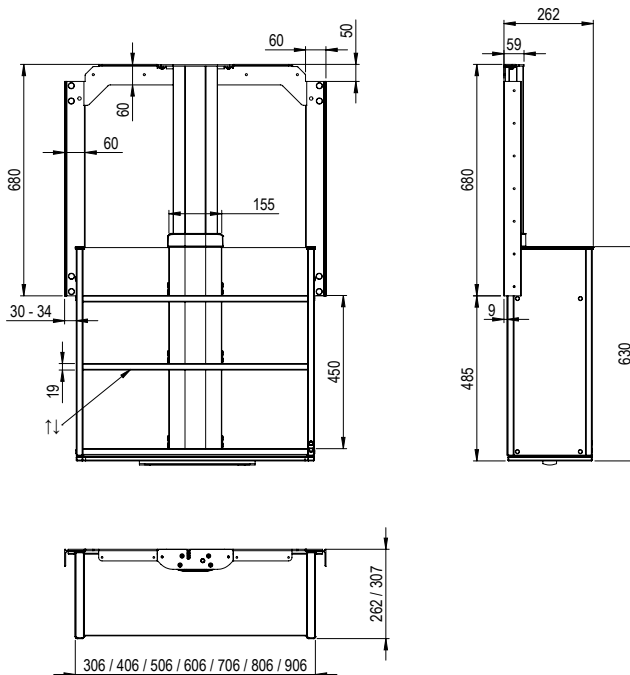

**VERTI 840K, height 70.0 cm**

**Measurement data:**  
 Cabinet width: 40.0-100.0 cm  
 Cabinet height: 70.0 cm or higher\*  
 Cabinet frame: 1.6-2.0 cm

**VERTI 840KA: 26.2 cm deep:**  
 Fits cabinets with inner depth: 26.7 - 31.1 cm



**VERTI 840KB: 30.7 cm deep:**  
 Fits cabinets with inner depth: From 31.2 cm



Cabinet width (cm)	Shelf width (cm)	Depth (cm)	Art. no.
40.0	30.5	26.2	840KA-040
50.0	40.5	26.2	840KA-050
60.0	50.5	26.2	840KA-060
70.0	60.5	26.2	840KA-070
80.0	70.5	26.2	840KA-080
90.0	80.5	26.2	840KA-090
100.0	90.5	26.2	840KA-100
40.0	30.5	30.7	840KB-040
50.0	40.5	30.7	840KB-050
60.0	50.5	30.7	840KB-060
70.0	60.5	30.7	840KB-070
80.0	70.5	30.7	840KB-080
90.0	80.5	30.7	840KB-090
100.0	90.5	30.7	840KB-100

\* For cabinets taller than 70.0 cm, a fixed shelf is placed in the upper part of the cabinet.



	<p><b>Control button in ALU-design</b> Wired, for recessed mounting Dimensions: 82 x 82 x 17 mm</p>	<p>61310</p>		<p><b>Multi-compartment frame, ALU-design</b> Collects power socket, power switch or control buttons in a multi-compartment frame</p>	<p>Two-compartment frame: 61352 153 x 82 x 9 mm Three-compartment frame: 61353 225 x 82 x 9 mm</p>
	<p><b>Radio controlled - Fixed mounting</b> Control button with built-in radio control of a lift.</p> <p>The button is recess fitted in the front of the worktop lift. (Requires no wiring).</p> <p>The delivery includes receiver, battery and control button.</p> <p>Dimensions: 82 x 82 x 17 mm (52 mm total depth)</p>	<p>61371</p>		<p><b>LED light ramp</b> Mounted under the safety plate. The lamp is energy-efficient and does not get hot. On/Off switch is on the lamp. Connects to a 230 V socket via the supplied transformer.</p> <p>Colour temperature: Warm white 3000K, 6.0 W Dimensions: 340 x 13 x 40 mm <b>NB! Does not fit VERTI 40.0 cm</b></p>	<p>For fixed cabinets 61931 For movable cabinets (with spiral cable) 61932</p>
	<p><b>Control button, Mini</b> Wired, for recessed mounting Diameter: 20 mm</p>	<p>61315</p>		<p><b>LED Spotlights</b> Mounted under the safety plate. The lights are energy-efficient and do not get hot. Connects to a 230 V socket via the supplied transformer.</p>	<p>3.0 W Ø 70 mm, H=11 mm For fixed cabinets 61941 For movable cabinets (with spiral cable) 61938</p>
	<p><b>Control button, Mini, Radio controlled</b> Mini control button with built-in radio control of a lift.</p> <p>The button is recess fitted in the front of the worktop lift. (Requires no wiring).</p> <p>The delivery includes receiver, battery and control button.</p> <p>Diameter: 20 mm</p>	<p>61376</p>		<p><b>Cable connection package Lighting</b> Set with spiral cable and pull-relief for connection of own lighting on movable cabinet.</p>	<p>61930</p>
 <p>Radio control for 1 lift</p>  <p>Radio control for 2-5 lifts</p>	<p><b>Radio control - Hand control</b> Dimensions: 38 x 110 x 10 mm</p>	<p>For one lift 61385 For two lifts 61387 For three lifts 61388 For four lifts 61389 For five lifts 61390</p>			
	<p><b>Extension frame for aluminium button</b> Enables surface mounting of aluminium buttons. Colour: White Dimensions: 82 x 82 x 52 mm</p>	<p>61355</p>			

# InDIAGO 510

Diagonal lifting system for wall cabinets

InDIAGO is a motorised lifting system that is lowered in a curved movement to the front of the work surface. The movement can be stopped at any height.

The lift does not make the cabinet protrude further from the wall and it does not take up much space in the cabinet. It is easily mounted in existing or new cabinets without the bottom of the cabinet having to be removed. Strip lighting and light ramps are not affected by the lift since the bottom of the cabinet is left intact.

The system also includes a function that automatically opens the doors when the unit is lowered. When the unit goes back into the cabinet, it slows down at the end so the doors are closed gently. The ingenious design also makes it possible to open the doors as usual when the unit is in the raised position.

The cabinet unit is available in two heights that fit 70 cm or 85 cm high cabinets. The lift is available in two different depths and in a wide range of widths to fit cabinets that are 50-100 cm wide.

The lift can be integrated in kitchens from any kitchen manufacturer.

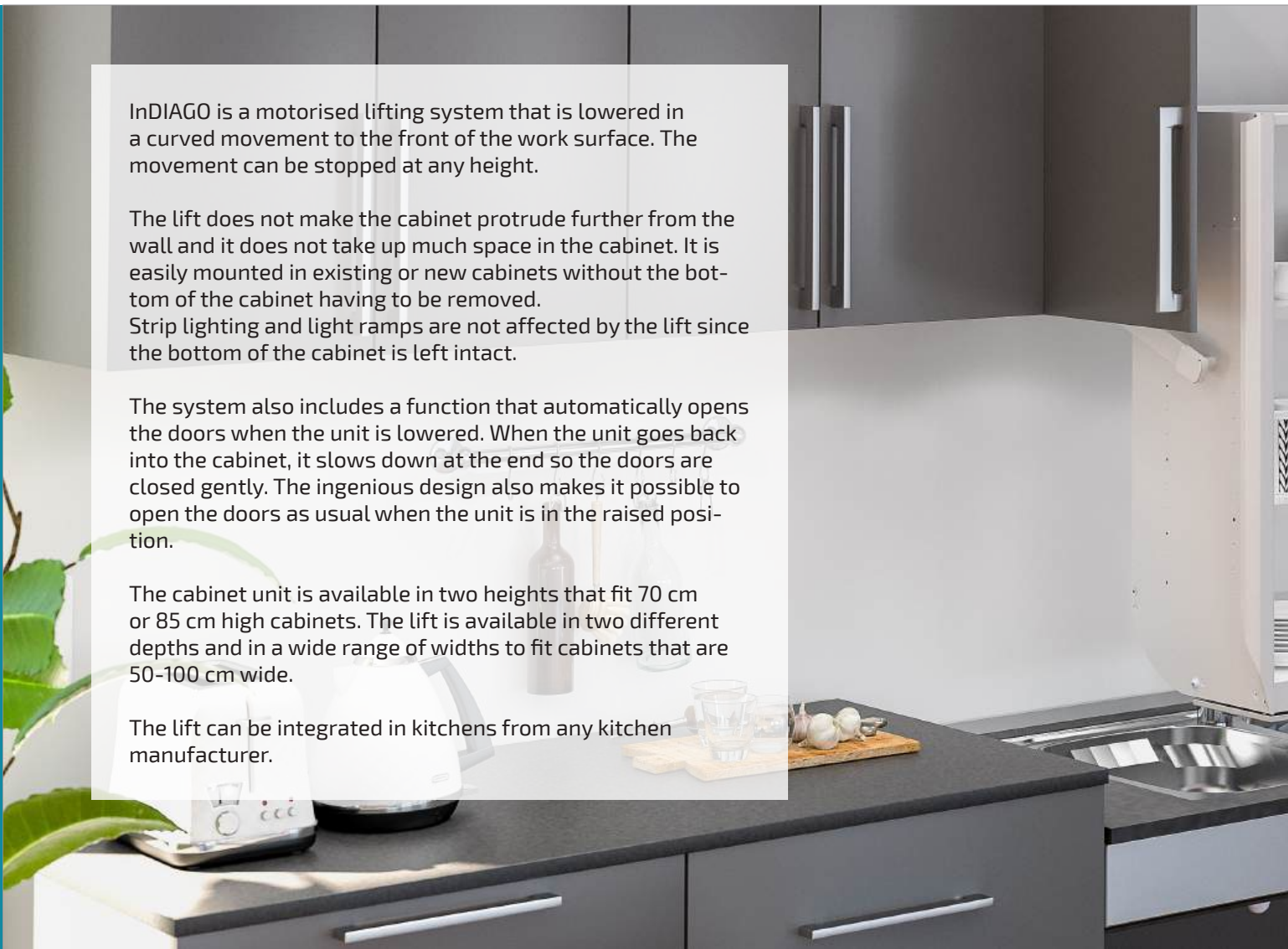

It is easy to reach the contents since the unit comes forward when lowered. The mechanics and motors are barely visible when the frame is lowered.



There is plenty of room for the mixer tap and other objects on the worktop when the frame is in the lowered position.



The mechanics and motors are optimally positioned so as to take up as little space as possible inside the cabinet.



### Functions and advantages

- Lowers the cabinet unit diagonally downwards and forwards to the front of the top board
- Easy to reach the contents since the unit moves forward as it is lowered
- When lowered, the cabinet unit passes in front of the mixer tap
- Easily mounted in new or existing cabinets without the bottom having to be removed. Strip lighting and light ramps are not affected
- Motor-driven automation that opens and closes the doors
- The lifting units are easily mounted in the cabinet. The lift is screwed to the inside of the cabinet
- The cabinet unit is delivered ready-mounted. Available in widths 50-100 cm
- The mechanics take up minimal space in the cabinet. Plates with a diameter of up to 29 cm can fit into the unit

### Standard equipment

- Control button
- Safety switch under the cabinet unit
- Motor-driven automation that opens and closes the doors

### Recommended additional options

- Lighting (mounted under the cabinet)

### Useful information

- Motorised, steplessly adjustable 540 mm downwards, 373 mm outwards
- Model 510A fits cabinets with an inner depth of 260-309 mm. The shelf depth is 230 mm
- Model 510B fits inside cabinets with a depth of minimum 310 mm. The depth of the shelf is 280 mm
- Available in two heights that fit a cabinet height of 700 mm or 850 mm (or higher)
- Electronics and motor system "Plug and Play"





### Specifications

<b>Lift model</b>	Diagonal lifting system for wall cabinets
<b>Height adjustment</b>	Motorised, steplessly adjustable 540 mm downwards, 373 mm outwards
<b>Speed</b>	23 mm/sec.
<b>Manoeuvring</b>	Wired button or radio control
<b>Automatic doors</b>	Motor-driven automation that opens and closes the doors
<b>Safety</b>	Safety plate under the lifting system. If anything touches the plate, the lift stops.
<b>Electricity connection</b>	Plug for 230 V, Max 2.0 A
<b>Lifting power</b>	40 kg
<b>IP Class</b>	IP30
<b>Height</b>	660 / 810 mm
<b>Fits cabinets with width</b>	500 - 1000 mm
<b>Fits cabinets with height</b>	700 cm or higher
<b>Fits cabinets with inner depth</b>	InDIAGO 510KA / 510SA: 260 - 309 mm, InDIAGO 510KB / 510SB: From 310 mm
<b>Fits cabinet frames with side thickness</b>	16-20 mm
<b>Material specifications</b>	Cabinet lifting system in powder-lacquered aluminium (white). Back and ceiling of HDF. Shelves of white melamine (16 mm). Powder-lacquered sheet metal parts (white)
<b>Warranty</b>	2 year
	<b>CE</b>

### Measurement data

(mm)

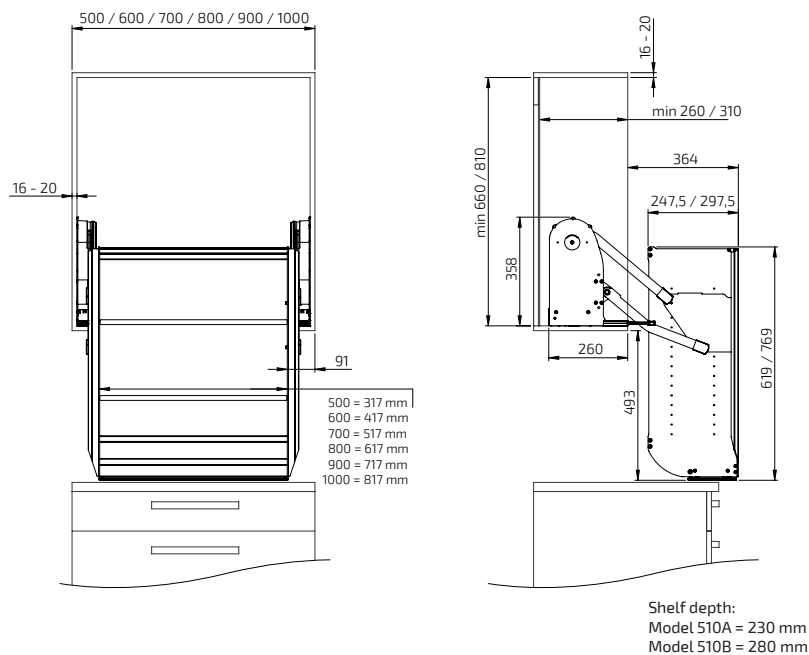

**InDIAGO 510, height 70.0 cm**

**Delivery includes:**  
Lifting unit  
Control unit and transformer  
Automatic doors

**Measurement data:**  
Cabinet width: 50.0-100.0 cm  
Cabinet height: 70.0-84.0 cm  
Fits cabinet frame: 1.6-2.0 cm

**InDIAGO 510KA: 26.0 cm deep:**  
Fits cabinets with inner depth: 26.0 - 30.9 cm

**InDIAGO 510KB: 31.0 cm deep:**  
Fits cabinets with inner depth: From 31.0 cm



**InDIAGO 510, height 85.0 cm**

**Delivery includes:**  
Lifting unit  
Control unit and transformer  
Automatic doors

**Measurement data:**  
Cabinet width: 50.0-100.0 cm  
Cabinet height: 85.0 cm or higher  
Fits cabinet frame: 1.6-2.0 cm







**InDIAGO 510SA: 26.0 cm deep:**  
Fits cabinets with inner depth: 26.0 - 30.9 cm

**InDIAGO 510SB: 31.0 cm deep:**  
Fits cabinets with inner depth: From 31.0 cm



	Cabinet width (cm)	Shelf width (cm)	Depth (cm)	Art. no.
Width of lift 46.0 cm	50.0	33.0	26.0	510KA-050
Width of lift 56.0 cm	60.0	43.0	26.0	510KA-060
Width of lift 66.0 cm	70.0	53.0	26.0	510KA-070
Width of lift 76.0 cm	80.0	63.0	26.0	510KA-080
Width of lift 86.0 cm	90.0	73.0	26.0	510KA-090
Width of lift 96.0 cm	100.0	83.0	26.0	510KA-100
Width of lift 46.0 cm	50.0	33.0	31.0	510KB-050
Width of lift 56.0 cm	60.0	43.0	31.0	510KB-060
Width of lift 66.0 cm	70.0	53.0	31.0	510KB-070
Width of lift 76.0 cm	80.0	63.0	31.0	510KB-080
Width of lift 86.0 cm	90.0	73.0	31.0	510KB-090
Width of lift 96.0 cm	100.0	83.0	31.0	510KB-100

	Cabinet width (cm)	Shelf width (cm)	Depth (cm)	Art. no.
Width of lift 46.0 cm	50.0	33.0	26.0	510SA-050
Width of lift 56.0 cm	60.0	43.0	26.0	510SA-060
Width of lift 66.0 cm	70.0	53.0	26.0	510SA-070
Width of lift 76.0 cm	80.0	63.0	26.0	510SA-080
Width of lift 86.0 cm	90.0	73.0	26.0	510SA-090
Width of lift 96.0 cm	100.0	83.0	26.0	510SA-100
Width of lift 46.0 cm	50.0	33.0	31.0	510SB-050
Width of lift 56.0 cm	60.0	43.0	31.0	510SB-060
Width of lift 66.0 cm	70.0	53.0	31.0	510SB-070
Width of lift 76.0 cm	80.0	63.0	31.0	510SB-080
Width of lift 86.0 cm	90.0	73.0	31.0	510SB-090
Width of lift 96.0 cm	100.0	83.0	31.0	510SB-100

	<p><b>Control button in ALU-design</b> Wired, for recessed mounting Dimensions: 82 x 82 x 17 mm</p>	<p>61210</p>
	<p><b>Radio controlled - Fixed mounting</b> Control button with built-in radio control of a lift. The button is recessed mounted in the front of the worktop lift. (Requires no wiring). The delivery includes receiver, battery and control button. Dimensions: 82 x 82 x 17 mm (52 mm total depth)</p>	<p>61370</p>
	<p><b>Control button, Mini</b> Wired, for recessed mounting Diameter: 20 mm</p>	<p>61316</p>
	<p><b>Control button, Mini, Radio controlled</b> Mini control button with built-in radio control of a lift. The button is recess fitted in the front of the worktop lift. (Requires no wiring). The delivery includes receiver, battery and control button. Diameter: 20 mm</p>	<p>61375</p>
 <p>Radio control for 1 lift</p> <p>Radio control for 2-5 lifts</p>	<p><b>Radio control - Hand control</b> Dimensions: 38 x 110 x 10 mm For one lift For two lifts For three lifts For four lifts For five lifts</p>	<p>61395 61396 61397 61398 61399</p>
	<p><b>Extension frame for aluminium button</b> Enables surface mounting of aluminium buttons. Colour: White Dimensions: 82 x 82 x 52 mm</p>	<p>61355</p>
	<p><b>Multi-compartment frame, ALU-design</b> Collects power socket, power switch or control buttons in a multi-compartment frame Two-compartment frame: 153 x 82 x 9 mm Three-compartment frame: 225 x 82 x 9 mm</p>	<p>61352 61353</p>



# DIAGO 504

Diagonal lifting system for wall cabinets

DIAGO 504 is an electrical height-adjustable lifting system used for the mounting of new or existing wall cabinets. The lift is a diagonal lift that lowers the cabinet in a curved motion downwards and forwards to the front of the work surface. The movement can be stopped at any height.

The lift is available in two widths that fit cabinets from 60.0 cm to 180 cm. The upper cabinet beam is adjustable to fit cabinet heights 70-110 cm. The cabinets can be fine-tuned in all planes (X, Y, Z) to fit the surrounding cabinets exactly. The lift protrudes 11 cm from the wall which must be taken into account when mounting the surrounding cabinets.

The lift is equipped with a reliable safety system that guarantees safe operation without any risk of pinching. Lighting and a light ramp can be mounted on the safety plates. The lift can be integrated with kitchens from any kitchen manufacturer.



DIAGO 504 brings the cabinets forward as they are lowered. This makes it easy to reach the cabinets even from a seated position.



Several cabinets can be mounted on the lift. (Max 180 cm). A microwave oven can also be lowered.



### Functions and advantages

- Lowers one or more cabinets diagonally downwards and forwards to the front of the worktop
- Takes up no space in the cabinet (mounted behind the cabinet)
- Easy to reach the contents since the cabinet comes forward when lowered
- Adjustable depth in all four corners provides the possibility to compensate for inclining wall
- Safety plate stops the lowering if it comes in contact with any object on the underlying work surface. Mounted under the cabinets
- Fits cabinets with height 70-110 cm
- Maximum cabinet width 180 cm

### Standard equipment

- Control button
- Safety switch in the form of safety plates that are screwed onto the underside of the cabinet

### Recommended additional options

- Lighting
- Screen

### Useful information

- Steplessly adjustable 435 mm downwards, 227 mm outwards
- Fits cabinets with height 700-1100 mm
- Fits cabinets with depth 260-400 mm
- When the lift is in the raised position, the cabinet protrudes 110 mm further. To conceal that, adjoining cabinets must be positioned so they protrude the same distance.
- There must be a gap for movement of 5-8 mm to the next cabinet/wall.





### Specifications

<b>Lift model</b>	Diagonal lifting system for wall cabinets
<b>Height adjustment</b>	Motorised, steplessly adjustable 435 mm downwards, 227 mm outwards
<b>Speed</b>	17 mm / sec.
<b>Manoeuvring</b>	Wired button or radio control
<b>Safety</b>	Safety plate mounted under the cabinet. If anything touches the plate, the lift stops.
<b>Electricity connection</b>	Plug for 230 V, Max 1.5 A
<b>Lifting power</b>	150 kg
<b>IP Class</b>	IPX4
<b>Frame height</b>	720 mm
<b>Frame width</b>	550 mm (cabinet width 600-1100 mm) 1150 mm (cabinet width 1200-1800 mm)
<b>Gap to adjoining cabinet/wall</b>	5 mm
<b>Protrudes from wall</b>	110 mm
<b>Fits cabinets width</b>	600 - 1800 mm
<b>Fits cabinets height</b>	700 - 1100 mm
<b>Fits cabinets depth</b>	260 - 400 mm
<b>Material specifications</b>	Powder-lacquered steel frame (Alu-grey RAL 9006), white-painted safety plates in 12 mm MDF, depth 350 mm
<b>Warranty</b>	2 year
	CE

### Measurement data

(mm)

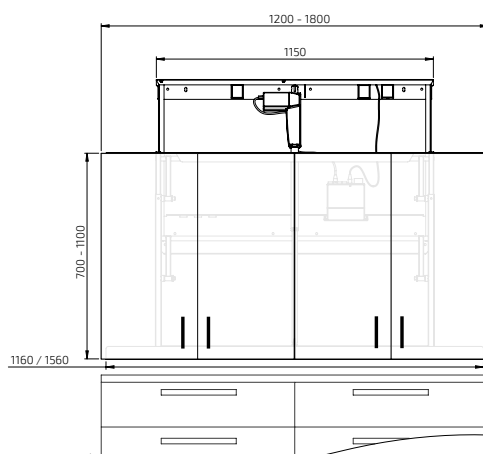
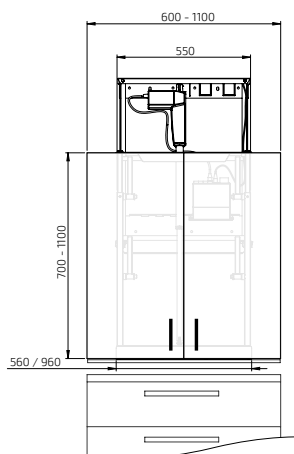
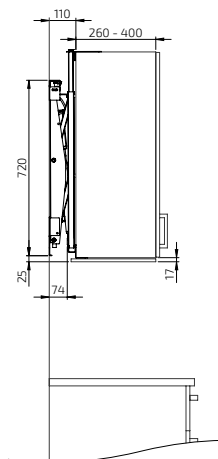
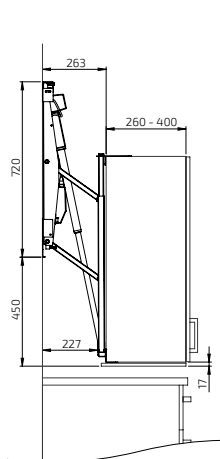

**DIAGO 504**

**Delivery includes:**  
 Lifting unit 55 cm wide  
 Adjustable cabinet beams  
 Safety plates

**Measurement data:**  
 Cabinet width: 60.0-110.0 cm  
 Cabinet height: 70.0-110.0 cm  
 Cabinet depth: 26.0-40.0 cm



**DIAGO 504**

**Delivery includes:**  
 Lifting unit 115 cm wide  
 Adjustable cabinet beams  
 Safety plates

**Measurement data:**  
 Cabinet width: 120.0-180.0 cm  
 Cabinet height: 70.0-110.0 cm  
 Cabinet depth: 26.0-40.0 cm



	Cabinet width (cm)	Planning width* (cm)	Cabinet beams, width (cm)	Art. no.
Safety plate (60.0 cm)	60.0	61.0	56.0	504-060
Safety plate (70.0 cm)	70.0	71.0	56.0	504-070
Safety plate (80.0 cm)	80.0	81.0	56.0	504-080
Safety plates (45.0 + 45.0 cm)	90.0	91.0	56.0	504-090
Safety plates (50.0 + 50.0 cm)	100.0	101.0	96.0	504-100
Safety plates (60.0 + 50.0 cm)	110.0	111.0	96.0	504-110

	Cabinet width (cm)	Planning width* (cm)	Cabinet beams, width (cm)	Art. no.
Safety plates (60.0 + 60.0 cm)	120.0	121.0	116.0	504-120
Safety plates (60.0 + 70.0 cm)	130.0	131.0	116.0	504-130
Safety plates (60.0 + 80.0 cm)	140.0	141.0	116.0	504-140
Safety plates (70.0 + 80.0 cm)	150.0	151.0	116.0	504-150
Safety plates (80.0 + 80.0 cm)	160.0	161.0	156.0	504-160
Safety plates (60.0 + 60.0 cm)	170.0	171.0	156.0	504-170
Safety plates (60.0+60.0+60.0 cm)	180.0	181.0	156.0	504-180

	<p><b>Lifting unit DIAGO 504</b> - Cabinet width 60.0-110.0 cm Colour: Alu-grey RAL 9006 Fits cabinets with height: 70.0-110.0 cm</p>	<p>504-055</p>		<p><b>Control button, Mini</b> Wired, for recessed mounting</p> <p>Diameter: 20 mm</p>	<p>61315</p>
	<p><b>Lifting unit DIAGO 504</b> - Cabinet width 120.0-180.0 cm Colour: Alu-grey RAL 9006 Fits cabinets with height: 70.0-110.0 cm</p>	<p>504-115</p>		<p><b>Control button, Mini, Radio controlled</b> Mini control button with built-in radio control of a lift.</p> <p>The button is recess fitted in the front of the worktop lift. (Requires no wiring). The delivery includes receiver, battery and control button.</p> <p>Diameter: 20 mm</p>	<p>61376</p>
	<p><b>Cabinet beams DIAGO 504</b> Upper and lower beam for the mounting of wall cabinets.</p> <p>For cabinets with width 60.0 cm</p> <p>For cabinets with width 100.0-110.0 cm</p> <p>For cabinets with width 120.0-150.0 cm</p> <p>For cabinets with width 160.0-180.0 cm</p>	<p>50450-056</p> <p>50450-096</p> <p>50450-116</p> <p>50450-156</p>	 <p>Radio control for 1 lift</p> <p>Radio control for 2-5 lifts</p>	<p><b>Radio control - Hand control</b> Dimensions: 38 x 110 x 10 mm</p> <p>For one lift</p> <p>For two lifts</p> <p>For three lifts</p> <p>For four lifts</p> <p>For five lifts</p>	<p>61385</p> <p>61387</p> <p>61388</p> <p>61389</p> <p>61390</p>
	<p><b>Safety plates DIAGO 504</b> The function of the safety plate is to stop the movement of the cabinet if the plate comes into contact with any object. Choose a plate that fits the width of the cabinet. Mounted under the wall cabinets Colour: White Thickness: 12 mm Depth: 350 - 400 mm</p> <p>Fits cabinets with width 40.0 cm</p> <p>Fits cabinets with width 45.0 cm</p> <p>Fits cabinets with width 50.0 cm</p> <p>Fits cabinets with width 60.0 cm</p> <p>Fits cabinets with width 70.0 cm</p> <p>Fits cabinets with width 80.0 cm</p> <p>For cabinets with width 90.0-180.0 cm, several safety plates are used together.</p>	<p>50431-4000</p> <p>50431-4500</p> <p>50431-5000</p> <p>50431-6000</p> <p>50431-7000</p> <p>50431-8000</p>		<p><b>Extension frame for aluminium button</b> Enables surface mounting of aluminium buttons. Colour: White Dimensions: 82 x 82 x 52 mm</p>	<p>61355</p>
	<p><b>Safety package for safety plate of your own design</b> The safety package contains micro-switch and cables for mounting in own board. Instructions with milling dimensions enclosed.</p> <p>Dimensions of board: Thickness: 12-16 mm Width: 400 - 800 mm Depth: 350 - 430 mm</p>	<p>50431-0000</p>		<p><b>Multi-compartment frame, ALU-design</b> Collects power socket, power switch or control buttons in a multi-compartment frame</p> <p>Two-compartment frame: 153 x 82 x 9 mm</p> <p>Three-compartment frame: 225 x 82 x 9 mm</p>	<p>61352</p> <p>61353</p>
	<p><b>Control button in ALU-design</b> Wired, for recessed mounting Dimensions: 82 x 82 x 17 mm</p>	<p>61310</p>		<p><b>LED Light ramp</b> Mounted under the safety plate. The lamp is energy-efficient and does not get hot. On/Off switch is on the lamp. Connects to a 230 V socket via the supplied transformer.</p> <p>Colour temperature: Warm white 3000K, 6.0 W Dimensions: 340 x 13 x 40 mm</p> <p>For fixed cabinets</p> <p>For movable cabinets (with spiral cable)</p>	<p>61931</p> <p>61933</p>
	<p><b>Radio controlled - Fixed mounting</b> Control button with built-in radio control of a lift.</p> <p>The button is recess mounted in the front of the worktop lift. (Requires no wiring).</p> <p>The delivery includes receiver, battery and control button.</p> <p>Dimensions: 82 x 82 x 17 mm (52 mm total depth)</p>	<p>61371</p>		<p><b>Cable connection package Lighting</b> Set with spiral cable and pull-relief for connection of own lighting on movable cabinet.</p>	<p>61930</p>
				<p><b>Screen</b> Mounted between the lift and the cabinet to conceal the lift as it is lowered. Colour: Grey</p> <p>Width 60.0 cm (For cabinet width 60.0 - 110.0 cm)</p> <p>Width 120.0 cm (For cabinet width 120.0 - 180.0 cm)</p>	<p>50460-060</p> <p>50460-120</p>



# Lifting systems for kitchen worktops

## Product overview

### BASELIFT 6300 / 6310

- Motorised height-adjustable straight worktop lift
- Wall-mounted or floor-mounted, 30 cm adjustable
- Choose between high or low front



### BASELIFT Corner 6301 / 6311

- Motorised height-adjustable corner worktop lift, 45° front, 90° wall
- Hob or sink bowl can be mounted in the corner module
- Wall-mounted or floor-mounted, 30 cm adjustable
- Choose between high or low front



### BASELIFT Corner 6302 / 6312

- Motorised height-adjustable corner worktop lift, 45° front, 45° wall
- Hob or sink bowl can be mounted in the corner module
- Wall-mounted or floor-mounted, 30 cm adjustable
- Choose between high or low front



### BASELIFT Corner 6303 / 6313

- Motorised height-adjustable corner worktop lift, 90° front, 90° wall
- Wall-mounted or floor-mounted, 30 cm adjustable
- Choose between high or low front



Our lifting systems for kitchen worktops are designed to be mounted in existing kitchens or as part of a new kitchen from any kitchen supplier. The worktops are available motorised or manually adjustable.

## SIDELIFT 6400

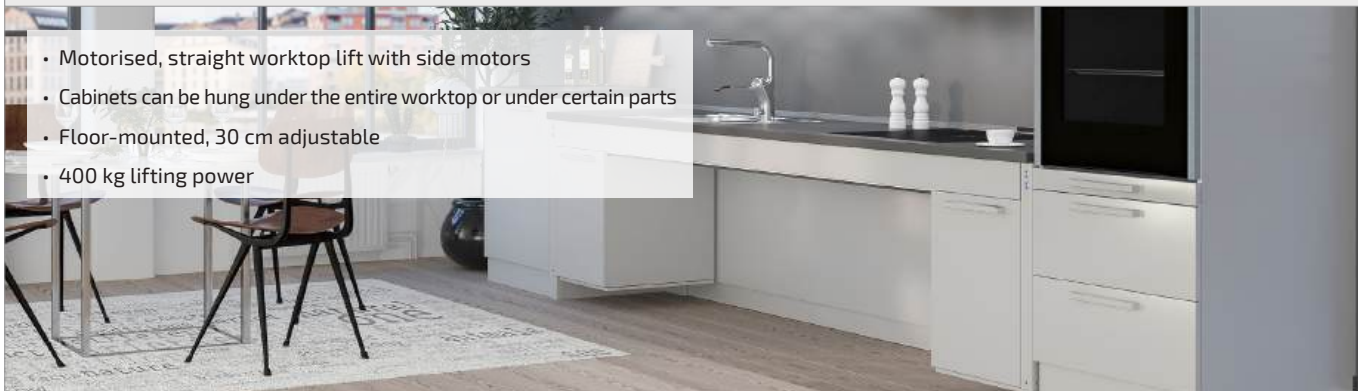

## MANULIFT 6350

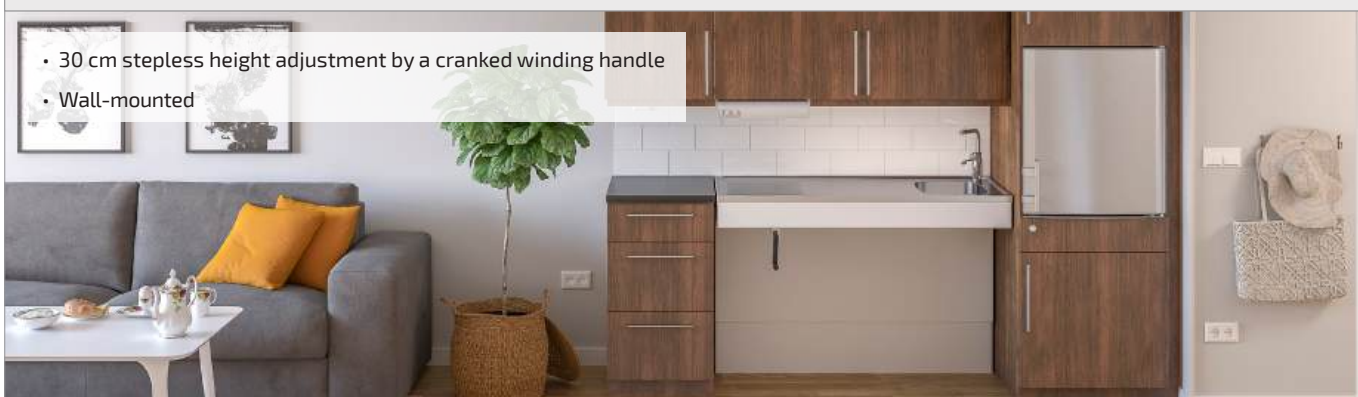

## MANULIFT 6380



# BASELIFT 6300 / 6310

Wall-mounted or floor-mounted motorised straight worktop lift

BASELIFT 6300/6310 is a straight, motorised worktop lift. Choose between wall-mounted or floor-mounted motors.

Under the worktop, space is left for the knees and legs. Installations under the worktop (motors, water, sewers) can be concealed by telescopic cover panels which gives the kitchen a neat look.

The motors work steplessly and adjust the worktop quickly and quietly to the desired height. The lift is equipped with a reliable safety system that guarantees safe operation without any risk of pinching.

The lift is prepared in the factory to facilitate easy installation.



The front of BASELIFT 6300H/6310H hides the sink bowls and gives a nice front. Installations under the worktop are hidden by cover panels.



BASELIFT 6300H/6310H can be fitted with a drawer at the front.





BASELIFT 6300L/6310L has a 40 mm front, which provides good accessibility for seated work.



The low front of BASELIFT 6300L/6310L means the lift is suitable for hobs.



### Functions and advantages

- Motorised, straight worktop lift
- Height-adjustable 70-100 cm above floor (excl. top board)
- The frame depth is adjustable 56-59 cm to fit adjoining cabinet
- The upper part of the lifting system is delivered ready-mounted. The sides are pre-assembled and adjustable side-ways to suit the sink, hob and drawers
- The lifting system is adjustable at an angle to compensate for an inclined wall
- Integrated safety switch
- 10 cm free space under motors for electrical installation and piping. (Applies to wall-mounted model)
- Choose floor-mounted model if there is no stable wall

### Standard equipment

- Factory-mounted aluminium system with movable and tiltable brackets
- Wall-mounted or floor-mounted motors
- Safety switch

### Recommended additional options

- Control button
- Front
- Hose cover/cover panels
- Sink (not 6300L/6310L)
- Drawer (not 6300L/6310L)
- Rear edge trim
- Top board
- Hob

### Useful information

- Fittings for top board and fronts enclosed
- The top board's depth must be 15 mm shallower than adjoining top boards (to provide a gap for tiles and movement)
- Width of the top board = width of the lift
- Sink bowls with a maximum height of 120 mm can be integrated (not 6300L/6310L)
- Electronics and motor system "Plug and Play"
- Width of front = width of lift - 4 mm  
Height of front: 6300H/6310H = 103 mm, 6300L/6310L = 40 mm  
Fittings enclosed
- Cover panels can hide installations under the worktop  
2 pcs width = width of lift - 10 mm, height 438 mm, thickness 12-20 mm

### Supplement with Plus module if you need a lift longer than 240 cm

The division should be as close to the middle as possible for even distribution of the engines.

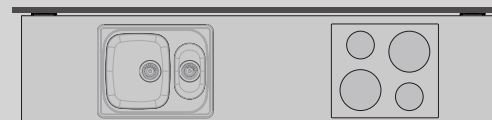

### Specify the location of drawers, sink and hob

The worktop is prepared in the factory. Drawers are mounted and sides assembled to facilitate the final mounting on the spot.

**WALL-MOUNTED**

6300H



6300L



**FLOOR-MOUNTED**

6310H



6310L



**Specifications**

<b>Mounting</b>	Wall or floor
<b>Height adjustment</b>	Motorised, steplessly adjustable 300 mm (700-1000 mm excl. top board)
<b>Speed</b>	30 mm / sec.
<b>Manoeuvring</b>	Recessed mounted button or radio control
<b>Safety</b>	The safety strip is placed under the front edge of the worktop. If anything touches the safety strip, the lifting unit stops
<b>Electricity connection</b>	Plug for 230 V, max 5.0 A
<b>Plumbing connections</b>	Connection is made with flexible hoses
<b>Lifting power</b>	100 kg
<b>IP Class</b>	IP 20
<b>Frame depth</b>	560-590 mm from wall
<b>Front height</b>	40 or 103 mm
<b>Dimensions cover panels</b>	2 pcs, width = width of the lift -10 mm, height 438 mm, thickness 12-20 mm
<b>Width top board</b>	Width = width of the lift
<b>Depth top board</b>	565-630 mm (15 mm shallower than worktops on fixed cabinets)
<b>Gap to the side to wall/adjoining cabinet</b>	5 mm
<b>Gap to wall (for tiling)</b>	15 mm
<b>Tiling</b>	From 700 mm above floor (alternatively all the way down to the floor)
<b>Delivery modules</b>	Ready-mounted worktop incl. safety switch, motors
<b>Fittings enclosed</b>	Bracket for front panels and top board
<b>Material specifications</b>	Aluminium frame
<b>Guarantee</b>	2 years
	<b>CE</b>

**Measurement data**

(mm)

**WALL-MOUNTED: 6300H/6300L**

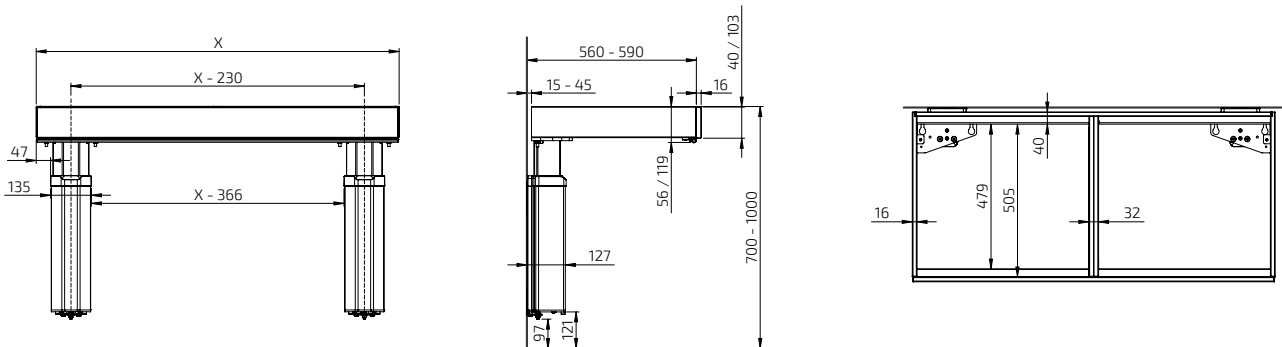

**FLOOR-MOUNTED: 6310H/6310L**

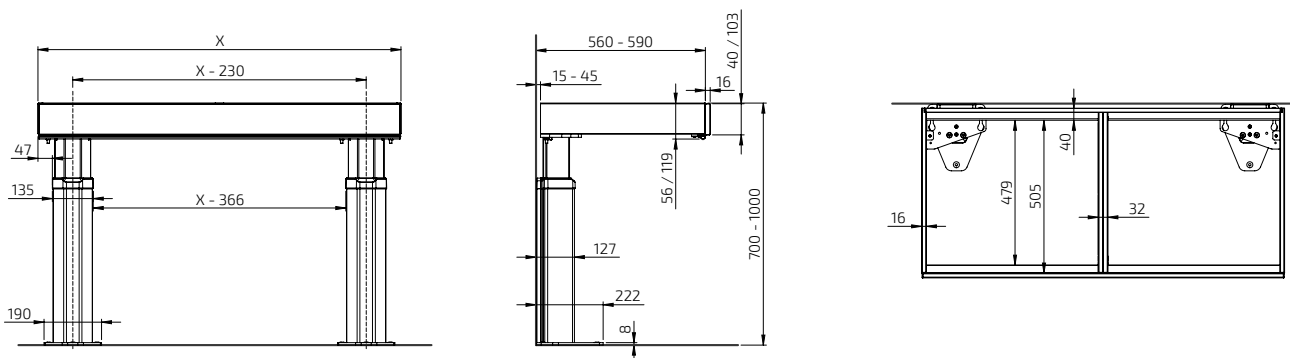

**BASELIFT 6300HA**

Wall-mounted lifting unit 59.0-100.0 cm width



Width (cm)	Art. no.
59.0	6300HA-059
60.0	6300HA-060
69.0	6300HA-069
70.0	6300HA-070
79.0	6300HA-079
80.0	6300HA-080
89.0	6300HA-089
90.0	6300HA-090
99.0	6300HA-099
100.0	6300HA-100

**BASELIFT 6310HA**

Floor-mounted lifting unit 59.0-100.0 cm width



Width (cm)	Art. no.
59.0	6310HA-059
60.0	6310HA-060
69.0	6310HA-069
70.0	6310HA-070
79.0	6310HA-079
80.0	6310HA-080
89.0	6310HA-089
90.0	6310HA-090
99.0	6310HA-099
100.0	6310HA-100

**BASELIFT 6300HA**

Wall-mounted lifting unit 109.0 - 180.0 cm width



109.0	6300HA-109
110.0	6300HA-110
119.0	6300HA-109
120.0	6300HA-120
129.0	6300HA-109
130.0	6300HA-130
139.0	6300HA-139
140.0	6300HA-140
149.0	6300HA-149
150.0	6300HA-150
159.0	6300HA-159
160.0	6300HA-160
169.0	6300HA-169
170.0	6300HA-170
179.0	6300HA-179
180.0	6300HA-180

**BASELIFT 6310HA**

Floor-mounted lifting unit 109.0 - 180.0 cm width



109.0	6310HA-109
110.0	6310HA-110
119.0	6310HA-109
120.0	6310HA-120
129.0	6310HA-109
130.0	6310HA-130
139.0	6310HA-139
140.0	6310HA-140
149.0	6310HA-149
150.0	6310HA-140
159.0	6310HA-149
160.0	6310HA-160
169.0	6310HA-149
170.0	6310HA-170
179.0	6310HA-179
180.0	6310HA-170

**BASELIFT 6300HA**

Wall-mounted lifting unit 189.0 - 240.0 cm width



189.0	6300HA-189
190.0	6300HA-189
199.0	6300HA-189
200.0	6300HA-200
209.0	6300HA-209
210.0	6300HA-210
219.0	6300HA-219
220.0	6300HA-220
229.0	6300HA-220
230.0	6300HA-230
239.0	6300HA-239
240.0	6300HA-240

**BASELIFT 6310HA**

Floor-mounted lifting unit 189.0 - 240.0 cm width



189.0	6310HA-189
190.0	6310HA-190
199.0	6310HA-199
200.0	6310HA-200
209.0	6310HA-209
210.0	6310HA-210
219.0	6310HA-219
220.0	6310HA-220
229.0	6310HA-219
230.0	6310HA-230
239.0	6310HA-239
240.0	6310HA-240

**Plus module BASELIFT 6306HA**

Wall-mounted Plus module 40.0-100.0 cm width



40.0	6306HA-040
50.0	6306HA-050
60.0	6306HA-060
70.0	6306HA-070
80.0	6306HA-080
90.0	6306HA-090
100.0	6306HA-100

**Plus module BASELIFT 6316HA**

Floor-mounted Plus module 40.0-100.0 cm width



40.0	6316HA-040
50.0	6316HA-050
60.0	6316HA-060
70.0	6316HA-070
80.0	6316HA-080
90.0	6316HA-090
100.0	6316HA-100

**Plus module BASELIFT 6306HA**

Wall-mounted Plus module 110.0-180.0 cm width



110.0	6306HA-110
120.0	6306HA-120
130.0	6306HA-130
140.0	6306HA-140
150.0	6306HA-150
160.0	6306HA-160
170.0	6306HA-170
180.0	6306HA-180

**Plus module BASELIFT 6316HA**

Floor-mounted Plus module 110.0-180.0 cm width



110.0	6316HA-110
120.0	6316HA-120
130.0	6316HA-130
140.0	6316HA-140
150.0	6316HA-150
160.0	6316HA-160
170.0	6316HA-170
180.0	6316HA-180

**Plus module BASELIFT 6306HA**

Wall-mounted Plusmodule 190.0-240.0 cm width



190.0	6306HA-190
200.0	6306HA-200
210.0	6306HA-210
220.0	6306HA-220
230.0	6306HA-230
240.0	6306HA-240





















**Plus module BASELIFT 6316HA**

Floor-mounted Plus module 190.0-240.0 cm width



190.0	6316HA-190
200.0	6316HA-200
210.0	6316HA-210
220.0	6316HA-220
230.0	6316HA-230
240.0	6316HA-240



	<p><b>Control button in ALU-design</b> Wired, for recessed mounting Dimensions: 82 x 82 x 17 mm</p>	<p>61320</p>		<p><b>Cutlery compartment</b> Fits 30.0 cm wide drawer 463-030 Fits 40.0 cm wide drawer 463-040 Fits 50.0 cm wide drawer 463-050 Fits 60.0 cm wide drawer 463-060 Fits 80.0 cm wide drawer 463-080</p>	
	<p><b>Control button, Mini</b> Wired, for recessed mounting Diameter: 20 mm</p>	<p>61318</p>		<p><b>Safety strip</b> Used if pinch protection is desired on the gable end (by an open side). Length: 370 mm, Height: 10 mm</p>	<p>61430</p>
 <p>Radio control for 1 lift Radio control for 2-5 lifts</p>	<p><b>Radio control - Hand control</b> Dimensions: 38 x 110 x 10 mm For one lift 61385 For two lifts 61387 For three lifts 61388 For four lifts 61389 For five lifts 61390</p>			<p><b>Safety panel, short end</b> Used when the worktop lift's underside passes over adjoining furnishings. Height: 263 mm, Depth: 400 mm <b>For a worktop lift with cover panels</b> Left 61442 Right 61443</p>	
	<p><b>Power Socket, Black</b> Diameter 68 mm, Drilling: 56 mm Installation depth 45 mm Cable length 2 m Earthed (EU 2-pin) 61333 Earthed (UK 3-pin) 61333.UK</p>			<p><b>Safety panel, short end</b> Used when the worktop lift's underside passes over adjoining furnishings. Height: 263 mm, Depth: 545 mm <b>For a worktop lift without cover panels</b> Left 61444 Right 61445</p>	
	<p><b>Socket, ALU-design</b> Earthed socket 230 V with flap cover. Dimensions: 82 x 82 x 17 mm Earthed (EU 2-pin) 61330</p>			<p><b>Hob cover under worktop lift</b> Provides a smooth underside. Used under the hob. White-lacquered metal RAL 9003 60.0 cm 6266-060 70.0 cm 6266-070 80.0 cm 6266-080 90.0 cm 6266-090 100.0 cm 6266-100</p>	
	<p><b>Power switch, ALU-design</b> For lighting, for example. The button has a sign for optional marking. Dimensions: 82 x 82 x 17 mm</p>	<p>61331</p>		<p><b>Cover panels</b> Used to cover installations under the worktop. 12 mm white melamine, 2 pcs height 438 mm 2 pcs are required for lengths over 2400 mm 6260-240</p>	
	<p><b>Multi-compartment frame, ALU-design</b> Collects power socket, power switch or control buttons in a multi-compartment frame. Two-compartment frame: 153 x 82 x 9 mm 61352 Three-compartment frame: 225 x 82 x 9 mm 61353</p>			<p><b>Fittings set for cover panels</b> Used to mount cover panels that conceal installations under the worktop. Colour: Alu-grey RAL 9006 2 pcs are required for lengths over 2400 mm 6260-005</p>	
	<p><b>Safety lock</b> Prevents unauthorised use. Dimensions: 23 x 9 mm</p>	<p>61360</p>		<p><b>Hose cover</b> The hose cover is mounted anywhere under the worktop, (next to motors, if applicable) to provide a neat coverage of hoses when the cover panels are not in use. Fittings are included. Width: 410 mm, Depth: 200 mm White plastic 61504-01 Grey plastic 61504-06</p>	
	<p><b>Front</b> Optional length, 20.0-340.0 cm Replace xxx with cm when ordering. Example, 385H-040-01 for 40.0 cm Height: 103 mm Lacquered aluminium, white RAL 9003 385H-xxx-01 Anodised aluminium 385H-xxx-06</p>			<p><b>Integrated drawer with full extension and soft-close or push-to-open function</b> Depth: 470 mm, height: 85 mm Colour: Anthracite (RAL 9004) 30.0 cm 465H-030 40.0 cm 465H-040 50.0 cm 465H-050 60.0 cm 465H-060 80.0 cm 465H-080 30.0 cm - Push-to-open function 466H-030 40.0 cm - Push-to-open function 466H-040 50.0 cm - Push-to-open function 466H-050 60.0 cm - Push-to-open function 466H-060 80.0 cm - Push-to-open function 466H-080</p>	
	<p><b>Rear edge trim in aluminium for top board</b> Mounted behind top board. Brushed aluminium Height above top board: 20 mm Thickness behind top board: 3 mm (per metre) 6943-06</p>			<p><b>Height-adjustment kit</b> Used to change stroke after installation. Contains programming box and memory adapter. 61400</p>	

**BASELIFT 6300LA**

Wall-mounted lifting unit 59.0-100.0 cm width



Width (cm)	Art. no.
59.0	6300LA-059
60.0	6300LA-060
69.0	6300LA-069
70.0	6300LA-070
79.0	6300LA-079
80.0	6300LA-080
89.0	6300LA-089
90.0	6300LA-090
99.0	6300LA-099
100.0	6300LA-100

**BASELIFT 6310LA**

Floor-mounted lifting unit 59.0-100.0 cm width



Width (cm)	Art. no.
59.0	6310LA-059
60.0	6310LA-060
69.0	6310LA-069
70.0	6310LA-070
79.0	6310LA-079
80.0	6310LA-080
89.0	6310LA-089
90.0	6310LA-090
99.0	6310LA-099
100.0	6310LA-100

**BASELIFT 6300LA**

Wall-mounted lifting unit 109.0 - 180.0 cm width



109.0	6300LA-100
110.0	6300LA-110
119.0	6300LA-119
120.0	6300LA-120
129.0	6300LA-129
130.0	6300LA-130
139.0	6300LA-139
140.0	6300LA-140
149.0	6300LA-149
150.0	6300LA-150
159.0	6300LA-159
160.0	6300LA-160
169.0	6300LA-169
170.0	6300LA-170
179.0	6300LA-179
180.0	6300LA-180

**BASELIFT 6310LA**

Floor-mounted lifting unit 109.0 - 180.0 cm width



109.0	6310LA-109
110.0	6310LA-110
119.0	6310LA-119
120.0	6310LA-120
129.0	6310LA-129
130.0	6310LA-130
139.0	6310LA-139
140.0	6310LA-140
149.0	6310LA-149
150.0	6310LA-150
159.0	6310LA-159
160.0	6310LA-160
169.0	6310LA-169
170.0	6310LA-170
179.0	6310LA-179
180.0	6310LA-180

**BASELIFT 6300LA**

Wall-mounted lifting unit 189.0 - 240.0 cm width



189.0	6300LA-189
190.0	6300LA-190
199.0	6300LA-199
200.0	6300LA-200
209.0	6300LA-209
210.0	6300LA-210
219.0	6300LA-219
220.0	6300LA-220
229.0	6300LA-229
230.0	6300LA-230
239.0	6300LA-239
240.0	6300LA-240

**BASELIFT 6310LA**

Floor-mounted lifting unit 189.0 - 240.0 cm width



189.0	6310LA-189
190.0	6310LA-190
199.0	6310LA-199
200.0	6310LA-200
209.0	6310LA-209
210.0	6310LA-210
219.0	6310LA-219
220.0	6310LA-220
229.0	6310LA-229
230.0	6310LA-230
239.0	6310LA-239
240.0	6310LA-240

**Plus module BASELIFT 6306LA**

Wall-mounted Plus module 40.0-100.0 cm width



40.0	6306LA-040
50.0	6306LA-050
60.0	6306LA-060
70.0	6306LA-070
80.0	6306LA-080
90.0	6306LA-090
100.0	6306LA-100

**Plus module BASELIFT 6316LA**

Floor-mounted Plus module 40.0-100.0 cm width



40.0	6316LA-040
50.0	6316LA-050
60.0	6316LA-060
70.0	6316LA-070
80.0	6316LA-080
90.0	6316LA-090
100.0	6316LA-100

**Plus module BASELIFT 6306LA**

Wall-mounted Plus module 110.0-180.0 cm width



110.0	6306LA-100
120.0	6306LA-120
130.0	6306LA-130
140.0	6306LA-140
150.0	6306LA-150
160.0	6306LA-160
170.0	6306LA-170
180.0	6306LA-180

**Plus module BASELIFT 6316LA**

Floor-mounted Plus module 110.0-180.0 cm width



110.0	6316LA-110
120.0	6316LA-120
130.0	6316LA-130
140.0	6316LA-140
150.0	6316LA-150
160.0	6316LA-160
170.0	6316LA-170
180.0	6316LA-180

**Plus module BASELIFT 6306LA**

Wall-mounted Plus module 190.0-240.0 cm width

















190.0	6306LA-190
200.0	6306LA-200
210.0	6306LA-210
220.0	6306LA-220
230.0	6306LA-230
240.0	6306LA-240

**Plus module BASELIFT 6316LA**

Floor-mounted Plus module 190.0-240.0 cm width



190.0	6316LA-190
200.0	6316LA-200
210.0	6316LA-210
220.0	6316LA-220
230.0	6316LA-230
240.0	6316LA-240

	<p><b>Control button, Mini</b></p> <p>Wired, for recessed mounting Diameter: 20 mm</p> <p>61318</p>		<p><b>Safety strip</b></p> <p>Used if pinch protection is desired on the gable end (by an open side). Length: 370 mm Height: 10 mm</p> <p>61430</p>
 <p>Radio control for 1 lift</p>  <p>Radio control for 2-5 lifts</p>	<p><b>Radio control - Hand control</b> Dimensions: 38 x 110 x 10 mm</p> <p>For one lift 61385</p> <p>For two lifts 61387</p> <p>For three lifts 61388</p> <p>For four lifts 61389</p> <p>For five lifts 61390</p>		<p><b>Safety panel, short end</b> Used when the worktop lift's underside passes over adjoining interior fittings. Height: 263 mm, Depth: 400 mm <b>For a worktop lift with cover panels</b></p> <p>Left 61442</p> <p>Right 61443</p>
	<p><b>Safety lock</b> Prevents unauthorised use. Dimensions: 23 x 9 mm</p> <p>61360</p>		<p><b>Safety panel, short end</b> Used when the worktop lift's underside passes over adjoining furnishings. Height: 263 mm, Depth: 545 mm <b>For a worktop lift without cover panels</b></p> <p>Left 61444</p> <p>Right 61445</p>
	<p><b>Front, white-lacquered aluminium</b></p> <p>Replace xxx with cm when ordering. Example, 385L-040-01 for 40.0 cm</p> <p>Lacquered aluminium, white RAL 9003 Height: 40 mm Optional length, 20.0-340.0 cm</p> <p>385L-xxx-01</p>		<p><b>Hob cover under worktop lift</b></p> <p>Provides a smooth underside. Used under the hob.</p> <p>White-lacquered metal RAL 9003</p> <p>60.0 cm 6266-060</p> <p>70.0 cm 6266-070</p> <p>80.0 cm 6266-080</p> <p>90.0 cm 6266-090</p> <p>100.0 cm 6266-100</p>
	<p><b>Front, anodised aluminium</b></p> <p>Replace xxx with cm when ordering. Example, 385L-040-06 for 40.0 cm</p> <p>Anodised aluminium Height: 40 mm Optional length, 20.0-340.0 cm</p> <p>385L-XXX-06</p>		<p><b>Cover panels</b> Used to cover installations under the worktop.</p> <p>Length is adapted to worktop lift's length.</p> <p>12 mm white melamine, 2 pcs height 438 mm 2 pcs are required for lengths over 2400 mm</p> <p>6260-240</p>
			<p><b>Fittings set for cover panels</b> Used to mount cover panels that conceal installations under the worktop.</p> <p>Colour: Alu-grey RAL 9006 2 pcs are required for lengths over 2400 mm</p> <p>6260-005</p>
			<p><b>Rear edge trim in aluminium for top board</b> Mounted behind top board. Brushed aluminium Height above top board: 20 mm Thickness behind top board: 3 mm (per metre)</p> <p>6943-06</p>
			<p><b>Height-adjustment kit</b> Used to change stroke after installation. Contains programming box and memory adapter.</p> <p>61400</p>

# BASELIFT Corner 6301 / 6311

Wall-mounted or floor-mounted motorised corner worktop lift, 45° front edge, 90° wall

BASELIFT Corner 6301/6311 is a motorised corner worktop lift with 45° front edge and 90° rear edge. Choose between wall-mounted or floor-mounted motors.

Under the worktop, space is left for the knees and legs. Installations under the worktop, (motors, water, sewers), can be concealed by telescopic cover panels which gives the kitchen a neat look.

The motors work steplessly and adjust the worktop quickly and quietly to the desired height. The lift is equipped with a reliable safety system that guarantees safe operation without any risk of pinching. The lift is prepared in the factory to facilitate easy installation.



Corner worktop lift with 45° slanted front edge provides ample legroom under the worktop while providing good access to the work surfaces on the sides. Installations under the worktop are hidden by cover panels.





Inset sink with a sink bowl can be integrated with the corner module. It is also possible to integrate a hob with the corner module.



A drawer can be integrated with the worktop.



### Functions and advantages

- Motorised corner worktop lift, 45° front edge, 90° wall
- Hob or sink bowl can be mounted in the corner module
- Height-adjustable 70-100 cm above the floor (excl. top board)
- The frame depth is adjustable 56-59 cm to fit adjoining cabinet
- The upper part of the lifting system is delivered ready-mounted. The sides are pre-assembled and adjustable side-ways to suit the sink, hob and drawers
- The lifting system is adjustable at an angle to compensate for an inclined wall
- Integrated safety switch
- 10 cm free space under motors for electrical installation and piping. (Applies to wall-mounted model)
- Choose floor-mounted model if there is no stable wall

### Standard equipment

- Factory-mounted aluminium system with movable and tiltable brackets
- Wall-mounted or floor-mounted motors
- Safety switch

### Recommended additional options

- Control button
- Front
- Hose cover/cover panels
- Sink (Not 6301L/6311L)
- Drawer (Not 6301L/6311L)
- Rear edge trim
- Top board
- Hob

### Useful information

- Fittings for top board and fronts enclosed
- The top board's depth must be 15 mm shallower than adjoining top boards (to provide a gap for tiles and movement)
- Width of the top board = width of the lift
- Sink bowls with a maximum height of 120 mm can be integrated (Not 6301L/6311L)
- Electronics and motor system "Plug and Play"
- Width of front = width of lift - 4 mm  
Height of front: 6301H/6311H = 103 mm, 6301L/6311L = 40 mm  
Fittings enclosed
- Cover panels can hide installations under the worktop  
2 pcs, height 438 mm, thickness 12-20 mm

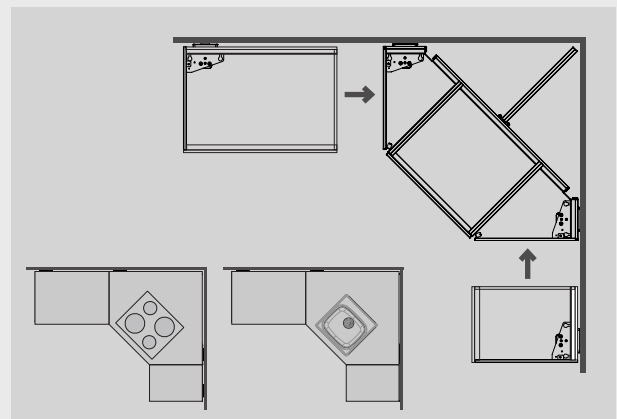

The corner module is equipped with two motors and can be used as one unit. Supplement with Plus modules to obtain the desired length on the left and right wings. A hob or sink bowl can be placed in the corner.

Specify the position of the drawers, sink and hob  
The worktop is prepared in the factory. Drawers are mounted and sides assembled to facilitate the final mounting on the spot.

**WALL-MOUNTED**

6301H



6301L



**FLOOR-MOUNTED**

6311H



6311L



**Specifications**

<b>Mounting</b>	Wall or floor
<b>Corner solution</b>	45° front edge, 90° wall
<b>Height adjustment</b>	Motorised, steplessly adjustable 300 mm (700-1000 mm excl. top board)
<b>Speed</b>	30 mm / sec.
<b>Manoeuvring</b>	Recessed mounted button or radio control
<b>Safety</b>	The safety strip is placed under the front edge of the worktop. If anything touches the safety strip, the lifting unit stops
<b>Electricity connection</b>	Plug for 230 V, 2 x 5A
<b>Plumbing connections</b>	Connection is made with flexible hoses
<b>Lifting power</b>	100 kg
<b>IP Class</b>	IP 20
<b>Frame depth</b>	560-590 mm from wall
<b>Front height</b>	40 or 103 mm
<b>Dimensions cover panels</b>	2 pcs, height 438 mm, thickness 12-20 mm
<b>Width top board</b>	Width = width of the lift
<b>Depth top board</b>	565-630 mm (15 mm shallower than worktops on fixed cabinets)
<b>Gap to the side to wall/adjoining cabinet</b>	5 mm
<b>Gap to wall (for tiling)</b>	15 mm
<b>Tiling</b>	From 700 mm above floor (alternatively all the way down to the floor)
<b>Delivery modules</b>	Ready-mounted worktop incl. safety switch, motors
<b>Fittings enclosed</b>	Bracket for fronts and top board
<b>Material specifications</b>	Aluminium frame
<b>Guarantee</b>	2 years
	<b>CE</b>

**Measurement data**

(mm)

**WALL-MOUNTED: 6301H/6301L**

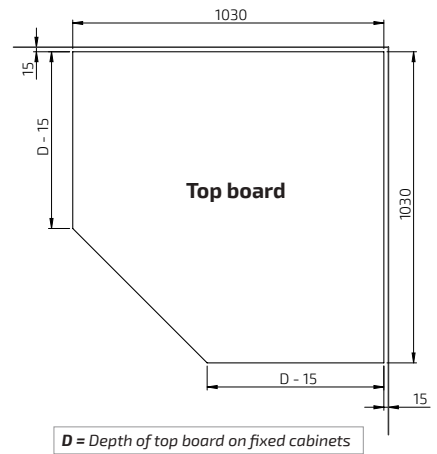
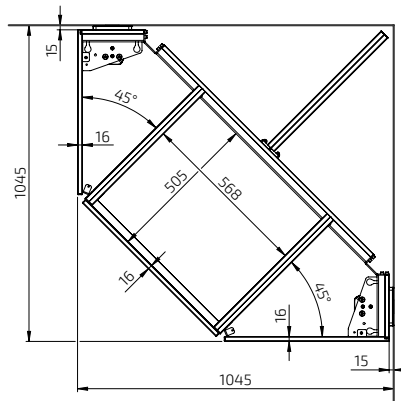
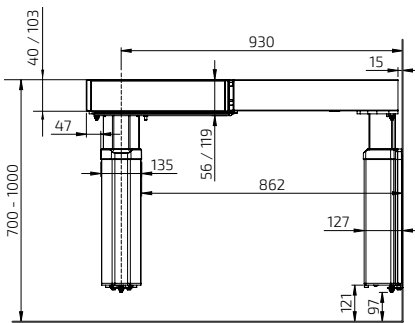

**FLOOR-MOUNTED: 6311H / 6311L**

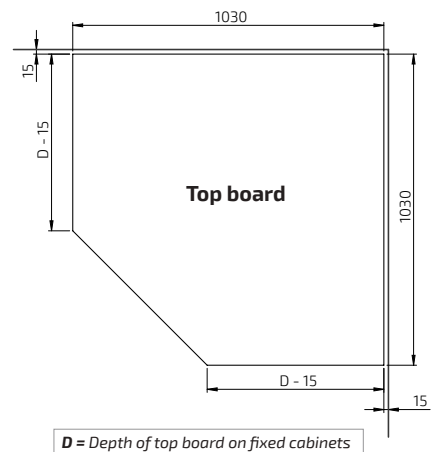
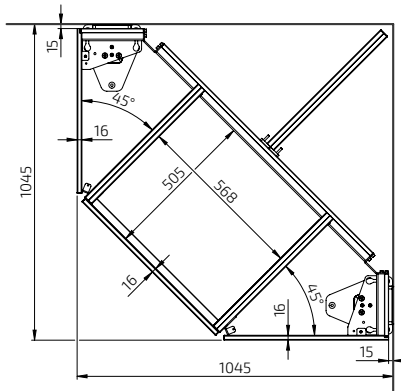
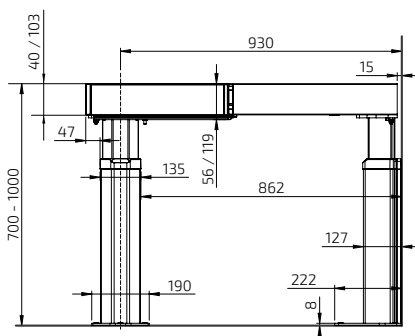

**BASELIFT Corner 6301HA - Wall-mounted**

Lifting unit 104.5 x 104.5 cm  
 For 103 mm front  
 Frame depth 56.0 - 59.0 cm  
 2 motors  
 Safety switch



**BASELIFT Corner 6311HA - Floor-mounted**

Lifting unit 104.5 x 104.5 cm  
 For 103 mm front  
 Frame depth 56.0 - 59.0 cm  
 2 motors  
 Safety switch



	Width (cm)	Art. no.
	104.5	6301HA-1045

**Plus module Left 6305HA, 40.0-100.0 cm**



40.0	6305HA-040
50.0	6305HA-050
60.0	6305HA-060
70.0	6305HA-070
80.0	6305HA-080
90.0	6305HA-090
100.0	6305HA-100

	Width (cm)	Art. no.
	104.5	6311HA-1045

**Plus module Left 6315HA, 40.0 - 100.0 cm**



40.0	6315HA-040
50.0	6315HA-150
60.0	6315HA-060
70.0	6315HA-070
80.0	6315HA-080
90.0	6315HA-090
100.0	6315HA-100

**Plus module Left 6305HA, 110.0-180.0 cm**



110.0	6305HA-110
120.0	6305HA-120
130.0	6305HA-130
140.0	6305HA-140
150.0	6305HA-150
160.0	6305HA-160
170.0	6305HA-170
180.0	6305HA-180

**Plus module Left 6315HA, 110.0 - 180.0 cm**



110.0	6315HA-110
120.0	6315HA-120
130.0	6315HA-130
140.0	6315HA-140
150.0	6315HA-150
160.0	6315HA-160
170.0	6315HA-170
180.0	6315HA-180

**Plus module Left 6305HA, 190.0-240.0 cm**



190.0	6305HA-190
200.0	6305HA-200
210.0	6305HA-210
220.0	6305HA-220
230.0	6305HA-230
240.0	6305HA-240

**Plus module Left 6315HA, 190.0 - 240.0 cm**



190.0	6315HA-190
200.0	6315HA-200
210.0	6315HA-210
220.0	6315HA-220
230.0	6315HA-230
240.0	6315HA-240

**Plus module Right 6306HA, 40.0-100.0 cm**



40.0	6306HA-040
50.0	6306HA-050
60.0	6306HA-060
70.0	6306HA-070
80.0	6306HA-080
90.0	6306HA-090
100.0	6306HA-100

**Plus module Right 6316HA, 40.0 - 100.0 cm**



40.0	6316HA-040
50.0	6316HA-050
60.0	6316HA-160
70.0	6316HA-070
80.0	6316HA-080
90.0	6316HA-090
100.0	6316HA-100

**Plus module Right 6306HA, 110.0 - 180.0 cm**



110.0	6306HA-110
120.0	6306HA-120
130.0	6306HA-130
140.0	6306HA-140
150.0	6306HA-150
160.0	6306HA-160
170.0	6306HA-170
180.0	6306HA-180

**Plus module Right 6316HA, 110.0 - 180.0 cm**



110.0	6316HA-110
120.0	6316HA-120
130.0	6316HA-130
140.0	6316HA-140
150.0	6316HA-150
160.0	6316HA-160
170.0	6316HA-170
180.0	6316HA-180

**Plus module Right 6306HA, 190.0 - 180.0 cm**



















190.0	6306HA-190
200.0	6306HA-200
210.0	6306HA-210
220.0	6306HA-220
230.0	6306HA-230
240.0	6306HA-240

**Plus module Right 6316HA, 190.0 - 240.0 cm**



190.0	6316HA-190
200.0	6316HA-200
210.0	6316HA-210
220.0	6316HA-220
230.0	6316HA-230
240.0	6316HA-240



	<p><b>Control button in ALU-design</b> Wired, for recessed mounting Dimensions: 82 x 82 x 17 mm</p>	<p>61320</p>		<p><b>Cutlery compartment</b> Fits 30.0 cm wide drawer 463-030 Fits 40.0 cm wide drawer 463-040 Fits 50.0 cm wide drawer 463-050 Fits 60.0 cm wide drawer 463-060 Fits 80.0 cm wide drawer 463-080</p>	
	<p><b>Control button, Mini</b> Wired, for recessed mounting Diameter: 20 mm</p>	<p>61318</p>		<p><b>Safety strip</b> Used if pinch protection is desired on the gable end (by an open side). Length: 370 mm, Height: 10 mm</p>	<p>61430</p>
	<p><b>Radio control - Hand control</b> Dimensions: 38 x 110 x 10 mm For one lift 61385 For two lifts 61387 For three lifts 61388 For four lifts 61389 For five lifts 61390</p>			<p><b>Safety panel, short end</b> Used when the worktop lift's underside passes over adjoining furnishings. Height: 263 mm, Depth: 400 mm <b>For a worktop lift with cover panels</b> Left 61442 Right 61443</p>	
	<p><b>Power Socket, Black</b> Diameter 68 mm, Drilling: 56 mm Installation depth 45 mm Cable length 2 m Earthed (EU 2-pin) 61333 Earthed (UK 3-pin) 61333.UK</p>			<p><b>Safety panel, short end</b> Used when the worktop lift's underside passes over adjoining furnishings. Height: 263 mm, Depth: 545 mm <b>For a worktop lift without cover panels</b> Left 61444 Right 61445</p>	
	<p><b>Socket, ALU-design</b> Earthed socket 230 V with flap cover. Dimensions: 82 x 82 x 17 mm Earthed (EU 2-pin) 61330</p>			<p><b>Hob cover under worktop lift</b> Provides a smooth underside. Used under the hob. White-lacquered metal RAL 9003 60.0 cm 6266-060 70.0 cm 6266-070 80.0 cm 6266-080 90.0 cm 6266-090 100.0 cm 6266-100</p>	
	<p><b>Power switch, ALU-design</b> For lighting, for example. The button has a sign for optional marking. Dimensions: 82 x 82 x 17 mm</p>	<p>61331</p>		<p><b>Cover panels</b> Used to cover installations under the worktop. 12 mm white melamine, 2 pcs height 438 mm 2 pcs are required for lengths over 2400 mm 6260-240</p>	
	<p><b>Multi-compartment frame, ALU-design</b> Collects power socket, power switch or control buttons in a multi-compartment frame. Two-compartment frame: 153 x 82 x 9 mm 61352 Three-compartment frame: 225 x 82 x 9 mm 61353</p>			<p><b>Fittings set for cover panels</b> Used to mount cover panels that conceal installations under the worktop. Colour: Alu-grey RAL 9006 2 pcs are required for lengths over 2400 mm 6260-005</p>	
	<p><b>Safety lock</b> Prevents unauthorised use. Dimensions: 23 x 9 mm</p>	<p>61360</p>		<p><b>Hose cover</b> The hose cover is mounted anywhere under the worktop, (next to motors, if applicable) to provide a neat coverage of hoses when the cover panels are not in use. Fittings are included. Width: 410 mm, Depth: 200 mm White plastic 61504-01 Grey plastic 61504-06</p>	
	<p><b>Front</b> Optional length, 20.0-340.0 cm Replace xxx with cm when ordering. Example, 385H-040-01 for 40.0 cm Height: 103 mm Lacquered aluminium, white RAL 9003 385H-xxx-01 Anodised aluminium 385H-xxx-06</p>			<p><b>Rear edge trim in aluminium for top board</b> Mounted behind top board. Brushed aluminium Height above top board: 20 mm Thickness behind top board: 3 mm (per metre) 6943-06</p>	
	<p><b>Integrated drawer with full extension and soft-close or push-to-open function</b> Depth: 470 mm, height: 85 mm Colour: Anthracite (RAL 9004) 30.0 cm 465H-030 40.0 cm 465H-040 50.0 cm 465H-050 60.0 cm 465H-060 80.0 cm 465H-080 30.0 cm - Push-to-open function 466H-030 40.0 cm - Push-to-open function 466H-040 50.0 cm - Push-to-open function 466H-050 60.0 cm - Push-to-open function 466H-060 80.0 cm - Push-to-open function 466H-080</p>			<p><b>Height-adjustment kit</b> Used to change stroke after installation. Contains programming box and memory adapter. 61400</p>	

**BASELIFT Corner 6301LA - Wall-mounted**

Lifting unit 104.5 x 104.5 cm  
 For 40 mm front  
 Frame depth 56.0 - 59.0 cm  
 2 motors  
 Safety switch



**BASELIFT Corner 6311LA-Floor-mounted**

Lifting unit 104.5 x 104.5 cm  
 For 40 mm front  
 Frame depth 56.0-59.0 cm  
 2 motors  
 Safety switch



	Width (cm)	Art. no.
	104.5	6301LA-1045

	Width (cm)	Art. no.
	104.5	6311LA-1045

**Plus module Left 6305LA, 40.0-100.0 cm**



40.0	6305LA-040
50.0	6305LA-050
60.0	6305LA-060
70.0	6305LA-070
80.0	6305LA-080
90.0	6305LA-090
100.0	6305LA-100

**Plus module Left 6315LA, 40.0 - 100.0 cm**



40.0	6315LA-040
50.0	6315LA-150
60.0	6315LA-060
70.0	6315LA-070
80.0	6315LA-080
90.0	6315LA-090
100.0	6315LA-100

**Plus module Left 6305LA, 110.0-180.0 cm**



110.0	6305LA-110
120.0	6305LA-120
130.0	6305LA-130
140.0	6305LA-140
150.0	6305LA-150
160.0	6305LA-160
170.0	6305LA-170
180.0	6305LA-180

**Plus module Left 6315LA, 110.0 - 180.0 cm**



110.0	6315LA-110
120.0	6315LA-120
130.0	6315LA-130
140.0	6315LA-140
150.0	6315LA-150
160.0	6315LA-160
170.0	6315LA-170
180.0	6315LA-180

**Plus module Left 6305LA, 190.0-240.0 cm**



190.0	6305LA-190
200.0	6305LA-200
210.0	6305LA-210
220.0	6305LA-220
230.0	6305LA-230
240.0	6305LA-240

**Plus module Left 6315LA, 190.0 - 240.0 cm**



190.0	6315LA-190
200.0	6315LA-200
210.0	6315LA-210
220.0	6315LA-220
230.0	6315LA-230
240.0	6315LA-240

**Plus module Right 6306LA, 40.0 - 100.0 cm**



40.0	6306LA-040
50.0	6306LA-050
60.0	6306LA-060
70.0	6306LA-070
80.0	6306LA-080
90.0	6306LA-090
100.0	6306LA-100

**Plus module Right 6316LA, 40.0 - 100.0 cm**



40.0	6316LA-040
50.0	6316LA-050
60.0	6316LA-160
70.0	6316LA-070
80.0	6316LA-080
90.0	6316LA-090
100.0	6316LA-100

**Plus module Right 6306LA, 110.0 - 180.0 cm**



110.0	6306LA-100
120.0	6306LA-120
130.0	6306LA-130
140.0	6306LA-140
150.0	6306LA-150
160.0	6306LA-160
170.0	6306LA-170
180.0	6306LA-180

**Plus module Right 6316LA, 110.0 - 180.0 cm**



110.0	6316LA-110
120.0	6316LA-120
130.0	6316LA-130
140.0	6316LA-140
150.0	6316LA-150
160.0	6316LA-160
170.0	6316LA-170
180.0	6316LA-180

**Plus module Right 6306LA, 190.0 - 240.0 cm**

















190.0	6306LA-190
200.0	6306LA-200
210.0	6306LA-210
220.0	6306LA-220
230.0	6306LA-230
240.0	6306LA-240

**Plus module Right 6316LA, 190.0 - 240.0 cm**



190.0	6316LA-190
200.0	6316LA-200
210.0	6316LA-210
220.0	6316LA-220
230.0	6316LA-230
240.0	6316LA-240

	<p><b>Control button, Mini</b></p> <p>Wired, for recessed mounting Diameter: 20 mm</p> <p>61318</p>		<p><b>Safety strip</b></p> <p>Used if pinch protection is desired on the gable end (by an open side). Length: 370 mm Height: 10 mm</p> <p>61430</p>
 <p>Radio control for 1 lift</p>  <p>Radio control for 2-5 lifts</p>	<p><b>Radio control - Hand control</b> Dimensions: 38 x 110 x 10 mm</p> <p>For one lift 61385</p> <p>For two lifts 61387</p> <p>For three lifts 61388</p> <p>For four lifts 61389</p> <p>For five lifts 61390</p>		<p><b>Safety panel, short end</b> Used when the worktop lift's underside passes over adjoining interior fittings. Height: 263 mm, Depth: 400 mm <b>For a worktop lift with cover panels</b></p> <p>Left 61442</p> <p>Right 61443</p>
	<p><b>Safety lock</b> Prevents unauthorised use. Dimensions: 23 x 9 mm</p> <p>61360</p>		<p><b>Safety panel, short end</b> Used when the worktop lift's underside passes over adjoining furnishings. Height: 263 mm, Depth: 545 mm <b>For a worktop lift without cover panels</b></p> <p>Left 61444</p> <p>Right 61445</p>
	<p><b>Front, white-lacquered aluminium</b></p> <p>Replace xxx with cm when ordering. Example, 385L-040-01 for 40.0 cm</p> <p>Lacquered aluminium, white RAL 9003 Height: 40 mm Optional length, 20.0-340.0 cm</p> <p>385L-xxx-01</p>		<p><b>Hob cover under worktop lift</b></p> <p>Provides a smooth underside. Used under the hob.</p> <p>White-lacquered metal RAL 9003</p> <p>60.0 cm 6266-060</p> <p>70.0 cm 6266-070</p> <p>80.0 cm 6266-080</p> <p>90.0 cm 6266-090</p> <p>100.0 cm 6266-100</p>
	<p><b>Front, anodised aluminium</b></p> <p>Replace xxx with cm when ordering. Example, 385L-040-06 for 40.0 cm</p> <p>Anodised aluminium Height: 40 mm Optional length, 20.0-340.0 cm</p> <p>385L-XXX-06</p>		<p><b>Cover panels</b> Used to cover installations under the worktop.</p> <p>Length is adapted to worktop lift's length.</p> <p>12 mm white melamine, 2 pcs height 438 mm 2 pcs are required for lengths over 2400 mm</p> <p>6260-240</p>
			<p><b>Fittings set for cover panels</b> Used to mount cover panels that conceal installations under the worktop.</p> <p>Colour: Alu-grey RAL 9006 2 pcs are required for lengths over 2400 mm</p> <p>6260-005</p>
			<p><b>Rear edge trim in aluminium for top board</b> Mounted behind top board. Brushed aluminium Height above top board: 20 mm Thickness behind top board: 3 mm (per metre)</p> <p>6943-06</p>
			<p><b>Height-adjustment kit</b> Used to change stroke after installation. Contains programming box and memory adapter.</p> <p>61400</p>

# BASELIFT Corner 6302 / 6312

Wall-mounted or floor-mounted motorised corner worktop lift, 45° front edge, 45° wall



Corner worktop lift with 45° slanted front edge and rear edge gives the kitchen an exclusive look, while providing good access to the work surfaces on the sides. Installations under the worktop are hidden by cover panels.



BASELIFT Corner 6302/6312 is a motorised corner worktop lift with 45° front edge and 45° rear edge. Choose between wall-mounted or floor-mounted motors.

Under the worktop, space is left for the knees and legs. Installations under the worktop, (motors, water, sewers) can be concealed with telescopic cover panels which gives the kitchen a neat look.

The motors work steplessly and adjust the worktop quickly and quietly to the desired height. The lift is equipped with a reliable safety system that guarantees safe operation without any risk of pinching. The lift is prepared in the factory to facilitate easy installation.

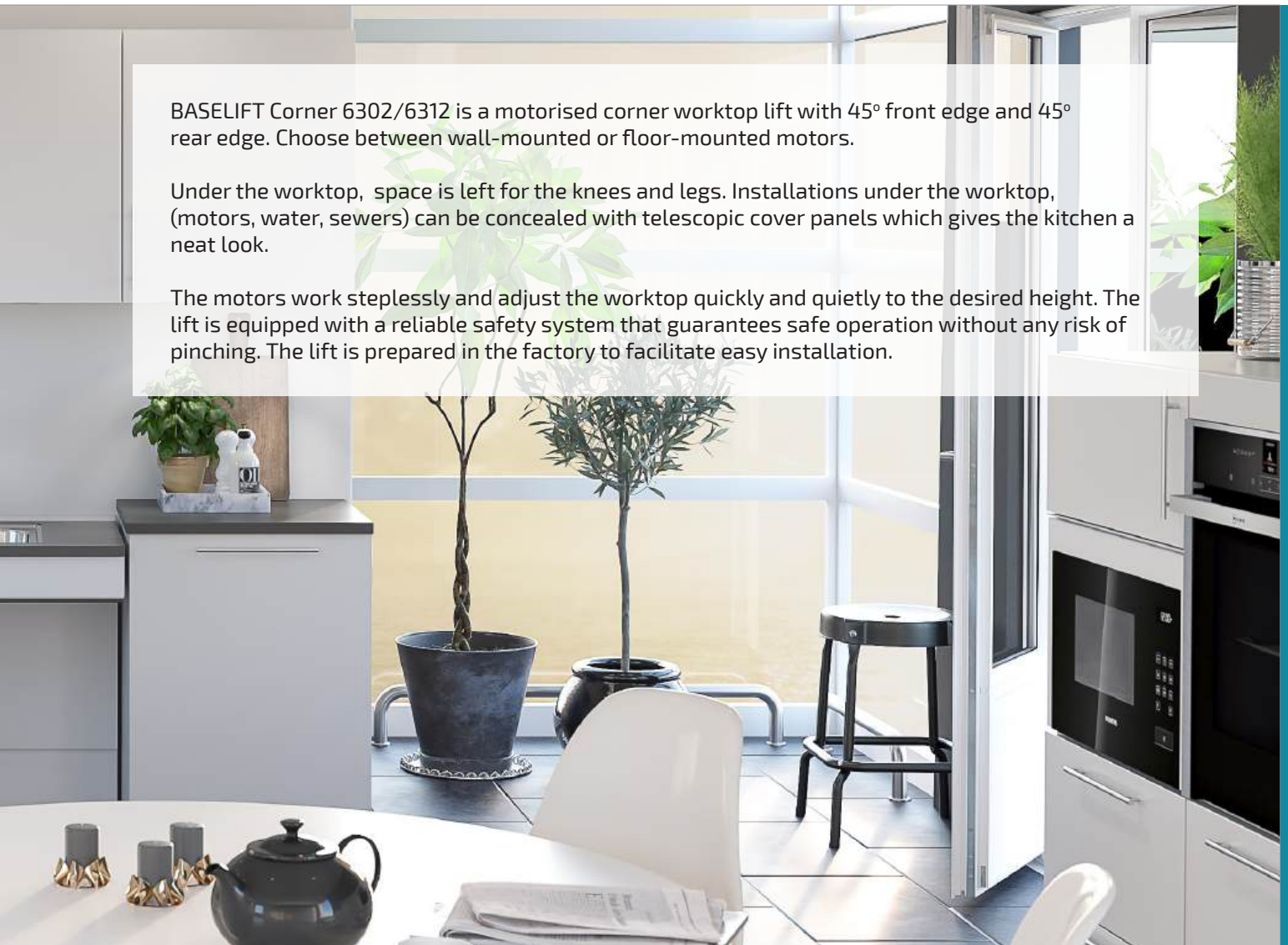

Hob can be integrated with the corner module. It is also possible to integrate the inset sink with a sink bowl in the corner module.



A drawer can be integrated with the worktop.



### Functions and advantages

- Motorised corner worktop lift, 45° front edge, 45° wall
- Hob or sink bowl can be mounted in the corner module
- Height-adjustable 70-100 cm above the floor (excl. top board)
- The frame depth is adjustable 56-59 cm to fit adjoining cabinet
- The upper part of the lifting system is delivered ready-mounted. The sides are pre-assembled and adjustable side-ways to suit the sink, hob and drawers
- The lifting system is adjustable at an angle to compensate for an inclined wall
- Integrated safety switch
- 10 cm free space under motors for electrical installation and piping. (Applies to wall-mounted model)
- Choose floor-mounted model if there is no stable wall

### Standard equipment

- Factory-mounted aluminium system with movable and tiltable brackets
- Wall-mounted or floor-mounted motors
- Safety switch

### Recommended additional options

- Control button
- Front
- Hose cover/cover panels
- Sink (Not 6302L/6312L)
- Drawer (Not 6302L/6312L)
- Rear edge trim
- Top board
- Hob

### Useful information

- Fittings for top board and fronts enclosed
- The top board's depth must be 15 mm shallower than adjoining top boards (to provide a gap for tiles and movement)
- Width of the top board = width of the lift
- Sink bowls with a maximum height of 120 mm can be integrated (Not 6302L/6312L)
- Electronics and motor system "Plug and Play"
- Width of front = width of lift - 4 mm  
Height of front: 6302H/6312H = 103 mm, 6302L/6312L = 40 mm  
Fittings enclosed
- Cover panels can hide installations under the worktop  
2 pcs, height 438 mm, thickness 12-20 mm

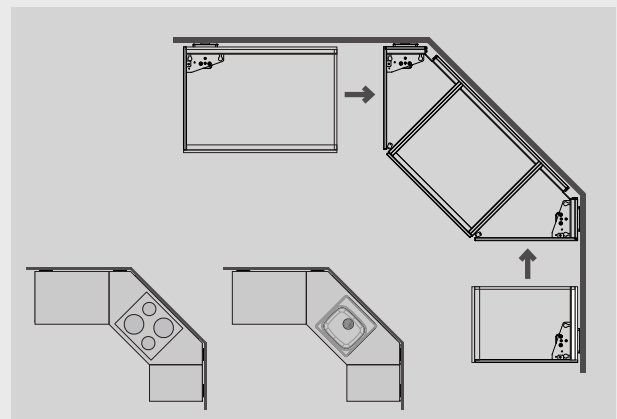

The corner module is equipped with two motors and can be used as one unit. Supplement with Plus modules to obtain the desired length on the left and right wings. A hob or sink bowl can be placed in the corner.

Specify the position of the drawers, sink and hob  
The worktop is prepared in the factory. Drawers are mounted and sides assembled to facilitate the final mounting on the spot.

**WALL-MOUNTED**

6302H



6302L



**FLOOR-MOUNTED**

6312H



6312L



**Specifications**

<b>Mounting</b>	Wall or floor
<b>Corner solution</b>	45° front edge, 45° wall
<b>Height adjustment</b>	Motorised, steplessly adjustable 300 mm (700-1000 mm excl. top board)
<b>Speed</b>	30 mm / sec.
<b>Manoeuvring</b>	Recessed mounted button or radio control
<b>Safety</b>	The safety strip is placed under the front edge of the worktop. If anything touches the safety strip, the lifting unit stops
<b>Electricity connection</b>	Plug for 230 V, 2 x 5A
<b>Plumbing connections</b>	Connection is made with flexible hoses
<b>Lifting power</b>	100 kg
<b>IP Class</b>	IP 20
<b>Frame depth</b>	560-590 mm from wall
<b>Front height</b>	40 or 103 mm
<b>Dimensions cover panels</b>	2 pcs, height 438 mm, thickness 12-20 mm
<b>Width top board</b>	Width = width of the lift
<b>Depth top board</b>	565-630 mm (15 mm shallower than worktops on fixed cabinets)
<b>Gap to the side to wall/adjoining cabinet</b>	5 mm
<b>Gap to wall (for tiling)</b>	15 mm
<b>Tiling</b>	From 700 mm above floor (alternatively all the way down to the floor)
<b>Delivery modules</b>	Ready-mounted worktop incl. safety switch, motors
<b>Fittings enclosed</b>	Bracket for fronts and top board
<b>Material specifications</b>	Aluminium frame
<b>Guarantee</b>	2 years
	<b>CE</b>

**Measurement data**

(mm)

WALL-MOUNTED: 6302H/6302L

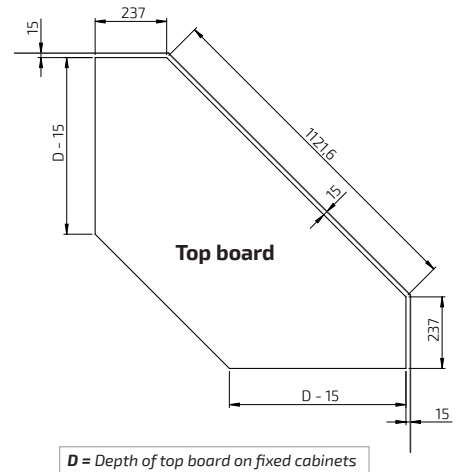
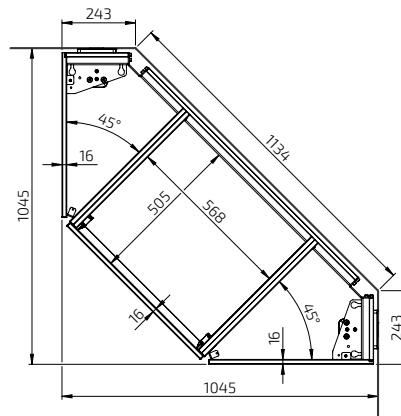
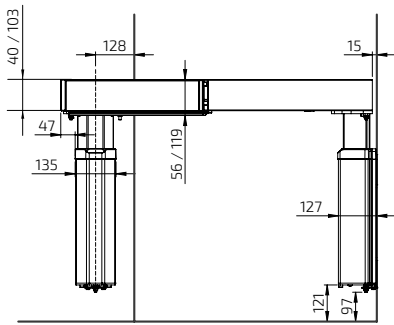

FLOOR-MOUNTED: 6312H / 6312L

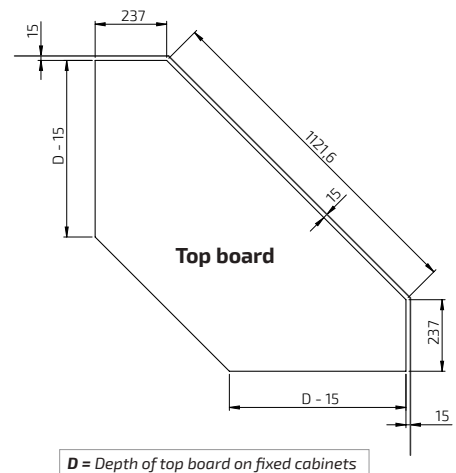
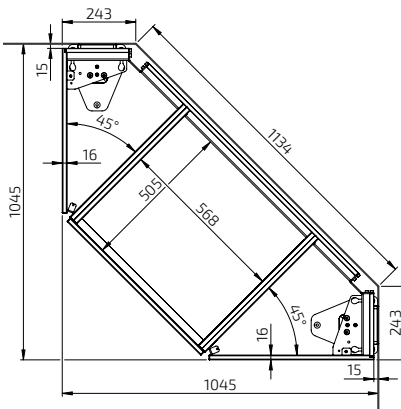
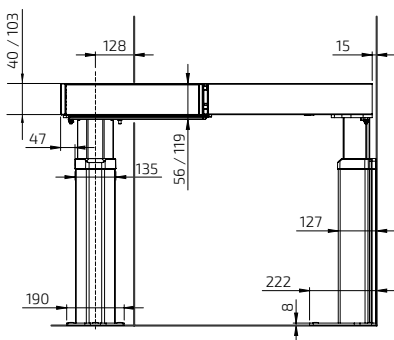

**BASELIFT Corner 6302HA - Wall-mounted**

Lifting unit 104.5 x 104.5 cm  
 For 103 mm front  
 Frame depth 56.0 - 59.0 cm  
 2 motors  
 Safety switch



**BASELIFT Corner 6302HA - Floor-mounted**

Lifting unit 104.5 x 104.5 cm  
 For 103 mm front  
 Frame depth 56.0 - 59.0 cm  
 2 motors  
 Safety switch



	Width (cm)	Art. no.
	104.5	6302HA-1045

	Width (cm)	Art. no.
	104.5	6312HA-1045

**Plus module Left 6305HA, 40.0-100.0 cm**



40.0	6305HA-040
50.0	6305HA-050
60.0	6305HA-060
70.0	6305HA-070
80.0	6305HA-080
90.0	6305HA-090
100.0	6305HA-100

**Plus module Left 6315HA, 40.0 - 100.0 cm**



40.0	6315HA-040
50.0	6315HA-150
60.0	6315HA-060
70.0	6315HA-070
80.0	6315HA-080
90.0	6315HA-090
100.0	6315HA-100

**Plus module Left 6305HA, 110.0-180.0 cm**



110.0	6305HA-110
120.0	6305HA-120
130.0	6305HA-130
140.0	6305HA-140
150.0	6305HA-150
160.0	6305HA-160
170.0	6305HA-170
180.0	6305HA-180

**Plus module Left 6315HA, 110.0 - 180.0 cm**



110.0	6315HA-110
120.0	6315HA-120
130.0	6315HA-130
140.0	6315HA-140
150.0	6315HA-150
160.0	6315HA-160
170.0	6315HA-170
180.0	6315HA-180

**Plus module Left 6305HA, 190.0-240.0 cm**



190.0	6305HA-190
200.0	6305HA-200
210.0	6305HA-210
220.0	6305HA-220
230.0	6305HA-230
240.0	6305HA-240

**Plus module Left 6315HA, 190.0 - 240.0 cm**



190.0	6315HA-190
200.0	6315HA-200
210.0	6315HA-210
220.0	6315HA-220
230.0	6315HA-230
240.0	6315HA-240

**Plus module Right 6306HA, 40.0-100.0 cm**



40.0	6306HA-040
50.0	6306HA-050
60.0	6306HA-060
70.0	6306HA-070
80.0	6306HA-080
90.0	6306HA-090
100.0	6306HA-100

**Plus module Right 6316HA, 40.0 - 100.0 cm**



40.0	6316HA-040
50.0	6316HA-050
60.0	6316HA-160
70.0	6316HA-070
80.0	6316HA-080
90.0	6316HA-090
100.0	6316HA-100

**Plus module Right 6306HA, 110.0 - 180.0 cm**



110.0	6306HA-110
120.0	6306HA-120
130.0	6306HA-130
140.0	6306HA-140
150.0	6306HA-150
160.0	6306HA-160
170.0	6306HA-170
180.0	6306HA-180

**Plus module Right 6316HA, 110.0 - 180.0 cm**



110.0	6316HA-110
120.0	6316HA-120
130.0	6316HA-130
140.0	6316HA-140
150.0	6316HA-150
160.0	6316HA-160
170.0	6316HA-170
180.0	6316HA-180

**Plus module Right 6306HA, 110.0 - 180.0 cm**



















190.0	6306HA-190
200.0	6306HA-200
210.0	6306HA-210
220.0	6306HA-220
230.0	6306HA-230
240.0	6306HA-240

**Plus module Right 6316HA, 190.0 - 240.0 cm**



190.0	6316HA-190
200.0	6316HA-200
210.0	6316HA-210
220.0	6316HA-220
230.0	6316HA-230
240.0	6316HA-240



	<p><b>Control button in ALU-design</b> Wired, for recessed mounting Dimensions: 82 x 82 x 17 mm</p> <p>61320</p>		<p><b>Cutlery compartment</b></p> <table border="1"> <tr><td>Fits 30.0 cm wide drawer</td><td>463-030</td></tr> <tr><td>Fits 40.0 cm wide drawer</td><td>463-040</td></tr> <tr><td>Fits 50.0 cm wide drawer</td><td>463-050</td></tr> <tr><td>Fits 60.0 cm wide drawer</td><td>463-060</td></tr> <tr><td>Fits 80.0 cm wide drawer</td><td>463-080</td></tr> </table>	Fits 30.0 cm wide drawer	463-030	Fits 40.0 cm wide drawer	463-040	Fits 50.0 cm wide drawer	463-050	Fits 60.0 cm wide drawer	463-060	Fits 80.0 cm wide drawer	463-080										
Fits 30.0 cm wide drawer	463-030																						
Fits 40.0 cm wide drawer	463-040																						
Fits 50.0 cm wide drawer	463-050																						
Fits 60.0 cm wide drawer	463-060																						
Fits 80.0 cm wide drawer	463-080																						
	<p><b>Control button, Mini</b> Wired, for recessed mounting Diameter: 20 mm</p> <p>61318</p>		<p><b>Safety strip</b> Used if pinch protection is desired on the gable end (by an open side). Length: 370 mm, Height: 10 mm</p> <p>61430</p>																				
	<p><b>Radio control - Hand control</b> Dimensions: 38 x 110 x 10 mm</p> <table border="1"> <tr><td>For one lift</td><td>61385</td></tr> <tr><td>For two lifts</td><td>61387</td></tr> <tr><td>For three lifts</td><td>61388</td></tr> <tr><td>For four lifts</td><td>61389</td></tr> <tr><td>For five lifts</td><td>61390</td></tr> </table>	For one lift	61385	For two lifts	61387	For three lifts	61388	For four lifts	61389	For five lifts	61390		<p><b>Safety panel, short end</b> Used when the worktop lift's underside passes over adjoining furnishings. Height: 263 mm, Depth: 400 mm <b>For a worktop lift with cover panels</b></p> <table border="1"> <tr><td>Left</td><td>61442</td></tr> <tr><td>Right</td><td>61443</td></tr> </table>	Left	61442	Right	61443						
For one lift	61385																						
For two lifts	61387																						
For three lifts	61388																						
For four lifts	61389																						
For five lifts	61390																						
Left	61442																						
Right	61443																						
	<p><b>Power Socket, Black</b> Diameter 68 mm, Drilling: 56 mm Installation depth 45 mm Cable length 2 m</p> <table border="1"> <tr><td>Earthed (EU 2-pin)</td><td>61333</td></tr> <tr><td>Earthed (UK 3-pin)</td><td>61333.UK</td></tr> </table>	Earthed (EU 2-pin)	61333	Earthed (UK 3-pin)	61333.UK		<p><b>Safety panel, short end</b> Used when the worktop lift's underside passes over adjoining furnishings. Height: 263 mm, Depth: 545 mm <b>For a worktop lift without cover panels</b></p> <table border="1"> <tr><td>Left</td><td>61444</td></tr> <tr><td>Right</td><td>61445</td></tr> </table>	Left	61444	Right	61445												
Earthed (EU 2-pin)	61333																						
Earthed (UK 3-pin)	61333.UK																						
Left	61444																						
Right	61445																						
	<p><b>Socket, ALU-design</b> Earthed socket 230 V with flap cover. Dimensions: 82 x 82 x 17 mm Earthed (EU 2-pin)</p> <p>61330</p>		<p><b>Hob cover under worktop lift</b> Provides a smooth underside. Used under the hob.</p> <table border="1"> <tr><td>White-lacquered metal RAL 9003</td><td></td></tr> <tr><td>60.0 cm</td><td>6266-060</td></tr> <tr><td>70.0 cm</td><td>6266-070</td></tr> <tr><td>80.0 cm</td><td>6266-080</td></tr> <tr><td>90.0 cm</td><td>6266-090</td></tr> <tr><td>100.0 cm</td><td>6266-100</td></tr> </table>	White-lacquered metal RAL 9003		60.0 cm	6266-060	70.0 cm	6266-070	80.0 cm	6266-080	90.0 cm	6266-090	100.0 cm	6266-100								
White-lacquered metal RAL 9003																							
60.0 cm	6266-060																						
70.0 cm	6266-070																						
80.0 cm	6266-080																						
90.0 cm	6266-090																						
100.0 cm	6266-100																						
	<p><b>Power switch, ALU-design</b> For lighting, for example. The button has a sign for optional marking. Dimensions: 82 x 82 x 17 mm</p> <p>61331</p>		<p><b>Cover panels</b> Used to cover installations under the worktop.</p> <table border="1"> <tr><td>12 mm white melamine, 2 pcs height 438 mm</td><td></td></tr> <tr><td>2 pcs are required for lengths over 2400 mm</td><td>6260-240</td></tr> </table>	12 mm white melamine, 2 pcs height 438 mm		2 pcs are required for lengths over 2400 mm	6260-240																
12 mm white melamine, 2 pcs height 438 mm																							
2 pcs are required for lengths over 2400 mm	6260-240																						
	<p><b>Multi-compartment frame, ALU-design</b> Collects power socket, power switch or control buttons in a multi-compartment frame.</p> <table border="1"> <tr><td>Two-compartment frame: 153 x 82 x 9 mm</td><td>61352</td></tr> <tr><td>Three-compartment frame: 225 x 82 x 9 mm</td><td>61353</td></tr> </table>	Two-compartment frame: 153 x 82 x 9 mm	61352	Three-compartment frame: 225 x 82 x 9 mm	61353		<p><b>Fittings set for cover panels</b> Used to mount cover panels that conceal installations under the worktop.</p> <table border="1"> <tr><td>Colour: Alu-grey RAL 9006</td><td></td></tr> <tr><td>2 pcs are required for lengths over 2400 mm</td><td>6260-005</td></tr> </table>	Colour: Alu-grey RAL 9006		2 pcs are required for lengths over 2400 mm	6260-005												
Two-compartment frame: 153 x 82 x 9 mm	61352																						
Three-compartment frame: 225 x 82 x 9 mm	61353																						
Colour: Alu-grey RAL 9006																							
2 pcs are required for lengths over 2400 mm	6260-005																						
	<p><b>Safety lock</b> Prevents unauthorised use. Dimensions: 23 x 9 mm</p> <p>61360</p>		<p><b>Hose cover</b> The hose cover is mounted anywhere under the worktop, (next to motors, if applicable) to provide a neat coverage of hoses when the cover panels are not in use. Fittings are included.</p> <table border="1"> <tr><td>Width: 410 mm, Depth: 200 mm</td><td></td></tr> <tr><td>White plastic</td><td>61504-01</td></tr> <tr><td>Grey plastic</td><td>61504-06</td></tr> </table>	Width: 410 mm, Depth: 200 mm		White plastic	61504-01	Grey plastic	61504-06														
Width: 410 mm, Depth: 200 mm																							
White plastic	61504-01																						
Grey plastic	61504-06																						
	<p><b>Front</b> Optional length, 20.0-340.0 cm <i>Replace xxx with cm when ordering. Example, 385H-040-01 for 40.0 cm</i> Height: 103 mm</p> <table border="1"> <tr><td>Lacquered aluminium, white RAL 9003</td><td>385H-xxx-01</td></tr> <tr><td>Anodised aluminium</td><td>385H-xxx-06</td></tr> </table>	Lacquered aluminium, white RAL 9003	385H-xxx-01	Anodised aluminium	385H-xxx-06		<p><b>Rear edge trim in aluminium for top board</b> Mounted behind top board. Brushed aluminium Height above top board: 20 mm Thickness behind top board: 3 mm (per metre)</p> <p>6943-06</p>																
Lacquered aluminium, white RAL 9003	385H-xxx-01																						
Anodised aluminium	385H-xxx-06																						
	<p><b>Integrated drawer with full extension and soft-close or push-to-open function</b> Depth: 470 mm, height: 85 mm Colour: Anthracite (RAL 9004)</p> <table border="1"> <tr><td>30.0 cm</td><td>465H-030</td></tr> <tr><td>40.0 cm</td><td>465H-040</td></tr> <tr><td>50.0 cm</td><td>465H-050</td></tr> <tr><td>60.0 cm</td><td>465H-060</td></tr> <tr><td>80.0 cm</td><td>465H-080</td></tr> <tr><td>30.0 cm - Push-to-open function</td><td>466H-030</td></tr> <tr><td>40.0 cm - Push-to-open function</td><td>466H-040</td></tr> <tr><td>50.0 cm - Push-to-open function</td><td>466H-050</td></tr> <tr><td>60.0 cm - Push-to-open function</td><td>466H-060</td></tr> <tr><td>80.0 cm - Push-to-open function</td><td>466H-080</td></tr> </table>	30.0 cm	465H-030	40.0 cm	465H-040	50.0 cm	465H-050	60.0 cm	465H-060	80.0 cm	465H-080	30.0 cm - Push-to-open function	466H-030	40.0 cm - Push-to-open function	466H-040	50.0 cm - Push-to-open function	466H-050	60.0 cm - Push-to-open function	466H-060	80.0 cm - Push-to-open function	466H-080		<p><b>Height-adjustment kit</b> Used to change stroke after installation. <i>Contains programming box and memory adapter.</i></p> <p>61400</p>
30.0 cm	465H-030																						
40.0 cm	465H-040																						
50.0 cm	465H-050																						
60.0 cm	465H-060																						
80.0 cm	465H-080																						
30.0 cm - Push-to-open function	466H-030																						
40.0 cm - Push-to-open function	466H-040																						
50.0 cm - Push-to-open function	466H-050																						
60.0 cm - Push-to-open function	466H-060																						
80.0 cm - Push-to-open function	466H-080																						

**BASELIFT Corner 6302LA - Wall-mounted**

Lifting unit 104.5 x 104.5 cm  
 For 40 mm front  
 Frame depth 56.0 - 59.0 cm  
 2 motors  
 Safety switch



**BASELIFT Corner 6312LA - Floor-mounted**

Lifting unit 104.5 x 104.5 cm  
 For 40 mm front  
 Frame depth 56.0 - 59.0 cm  
 2 motors  
 Safety switch



	Width (cm)	Art. no.
	104.5	6302LA-1045

	Width (cm)	Art. no.
	104.5	6312LA-1045

**Plus module Left 6305LA, 40.0-100.0 cm**



40.0	6305LA-040
50.0	6305LA-050
60.0	6305LA-060
70.0	6305LA-070
80.0	6305LA-080
90.0	6305LA-090
100.0	6305LA-100

**Plus module Left 6315LA, 40.0 - 100.0 cm**



40.0	6315LA-040
50.0	6315LA-150
60.0	6315LA-060
70.0	6315LA-070
80.0	6315LA-080
90.0	6315LA-090
100.0	6315LA-100

**Plus module Left 6305LA, 110.0-180.0 cm**



110.0	6305LA-110
120.0	6305LA-120
130.0	6305LA-130
140.0	6305LA-140
150.0	6305LA-150
160.0	6305LA-160
170.0	6305LA-170
180.0	6305LA-180

**Plus module Left 6315LA, 110.0 - 180.0 cm**



110.0	6315LA-110
120.0	6315LA-120
130.0	6315LA-130
140.0	6315LA-140
150.0	6315LA-150
160.0	6315LA-160
170.0	6315LA-170
180.0	6315LA-180

**Plus module Left 6305LA, 190.0-240.0 cm**



190.0	6305LA-190
200.0	6305LA-200
210.0	6305LA-210
220.0	6305LA-220
230.0	6305LA-230
240.0	6305LA-240

**Plus module Left 6315LA, 190.0 - 240.0 cm**



190.0	6315LA-190
200.0	6315LA-200
210.0	6315LA-210
220.0	6315LA-220
230.0	6315LA-230
240.0	6315LA-240

**Plus module Right 6306LA, 40.0 - 100.0 cm**



40.0	6306LA-040
50.0	6306LA-050
60.0	6306LA-060
70.0	6306LA-070
80.0	6306LA-080
90.0	6306LA-090
100.0	6306LA-100

**Plus module Right 6316LA, 40.0 - 100.0 cm**



40.0	6316LA-040
50.0	6316LA-050
60.0	6316LA-160
70.0	6316LA-070
80.0	6316LA-080
90.0	6316LA-090
100.0	6316LA-100

**Plus module Right 6306LA, 110.0 - 180.0 cm**



110.0	6306LA-100
120.0	6306LA-120
130.0	6306LA-130
140.0	6306LA-140
150.0	6306LA-150
160.0	6306LA-160
170.0	6306LA-170
180.0	6306LA-180

**Plus module Right 6316LA, 110.0 - 180.0 cm**



110.0	6316LA-110
120.0	6316LA-120
130.0	6316LA-130
140.0	6316LA-140
150.0	6316LA-150
160.0	6316LA-160
170.0	6316LA-170
180.0	6316LA-180

**Plus module Right 6306LA, 190.0 - 240.0 cm**

















190.0	6306LA-190
200.0	6306LA-200
210.0	6306LA-210
220.0	6306LA-220
230.0	6306LA-230
240.0	6306LA-240

**Plus module Right 6316LA, 190.0 - 240.0 cm**



190.0	6316LA-190
200.0	6316LA-200
210.0	6316LA-210
220.0	6316LA-220
230.0	6316LA-230
240.0	6316LA-240

	<p><b>Control button, Mini</b></p> <p>Wired, for recessed mounting Diameter: 20 mm</p> <p>61318</p>		<p><b>Safety strip</b></p> <p>Used if pinch protection is desired on the gable end (by an open side). Length: 370 mm Height: 10 mm</p> <p>61430</p>
 <p>Radio control for 1 lift</p>  <p>Radio control for 2-5 lifts</p>	<p><b>Radio control - Hand control</b> Dimensions: 38 x 110 x 10 mm</p> <p>For one lift 61385</p> <p>For two lifts 61387</p> <p>For three lifts 61388</p> <p>For four lifts 61389</p> <p>For five lifts 61390</p>		<p><b>Safety panel, short end</b> Used when the worktop lift's underside passes over adjoining interior fittings. Height: 263 mm, Depth: 400 mm <b>For a worktop lift with cover panels</b></p> <p>Left 61442</p> <p>Right 61443</p>
	<p><b>Safety lock</b> Prevents unauthorised use. Dimensions: 23 x 9 mm</p> <p>61360</p>		<p><b>Safety panel, short end</b> Used when the worktop lift's underside passes over adjoining furnishings. Height: 263 mm, Depth: 545 mm <b>For a worktop lift without cover panels</b></p> <p>Left 61444</p> <p>Right 61445</p>
	<p><b>Front, white-lacquered aluminium</b></p> <p>Replace xxx with cm when ordering. Example, 385L-040-01 for 40.0 cm</p> <p>Lacquered aluminium, white RAL 9003 Height: 40 mm Optional length, 20.0-340.0 cm</p> <p>385L-xxx-01</p>		<p><b>Hob cover under worktop lift</b></p> <p>Provides a smooth underside. Used under the hob.</p> <p>White-lacquered metal RAL 9003</p> <p>60.0 cm 6266-060</p> <p>70.0 cm 6266-070</p> <p>80.0 cm 6266-080</p> <p>90.0 cm 6266-090</p> <p>100.0 cm 6266-100</p>
	<p><b>Front, anodised aluminium</b></p> <p>Replace xxx with cm when ordering. Example, 385L-040-06 for 40.0 cm</p> <p>Anodised aluminium Height: 40 mm Optional length, 20.0-340.0 cm</p> <p>385L-XXX-06</p>		<p><b>Cover panels</b> Used to cover installations under the worktop.</p> <p>Length is adapted to worktop lift's length.</p> <p>12 mm white melamine, 2 pcs height 438 mm 2 pcs are required for lengths over 2400 mm</p> <p>6260-240</p>
	<p><b>Fittings set for cover panels</b> Used to mount cover panels that conceal installations under the worktop.</p> <p>Colour: Alu-grey RAL 9006 2 pcs are required for lengths over 2400 mm</p> <p>6260-005</p>		<p><b>Rear edge trim in aluminium for top board</b> Mounted behind top board. Brushed aluminium Height above top board: 20 mm Thickness behind top board: 3 mm (per metre)</p> <p>6943-06</p>
	<p><b>Height-adjustment kit</b> Used to change stroke after installation. Contains programming box and memory adapter.</p> <p>61400</p>		<p><b>Height-adjustment kit</b> Used to change stroke after installation. Contains programming box and memory adapter.</p> <p>61400</p>

# BASELIFT Corner 6303 / 6313

Wall-mounted or floor-mounted motorised corner worktop lift, 90° front edge, 90° wall

BASELIFT Corner 6303/6313 is a motorised corner worktop lift with 90° front edge and 90° rear edge. Choose between wall-mounted or floor-mounted motors.

Under the worktop, space is left for the knees and legs. Installations under the worktop, (motors, water, sewers) can be concealed with telescopic cover panels which gives the kitchen a neat look.

The motors work steplessly and adjust the worktop quickly and quietly to the desired height. The lift is equipped with a reliable safety system that guarantees safe operation without any risk of pinching. The lift is prepared in the factory to facilitate easy installation.



Corner worktop lift with 90° front edge and rear edge provides good access to the work surfaces on the sides. Installations under the worktop are hidden by cover panels.





Inset sink and hob can be integrated into the worktop.



A drawer can be integrated with the worktop.



### Functions and advantages

- Motorised corner worktop lift, 90° front edge, 90° wall
- Height-adjustable 70-100 cm above the floor (excl. top board)
- The frame depth is adjustable 56-59 cm to fit adjoining cabinet
- The upper part of the lifting system is delivered ready-mounted. The sides are pre-assembled and adjustable side-ways to suit the sink, hob and drawers
- The lifting system is adjustable at an angle to compensate for an inclined wall
- Integrated safety switch
- 10 cm free space under motors for electrical installation and piping. (Applies to wall-mounted model)
- Choose floor-mounted model if there is no stable wall

### Standard equipment

- Factory-mounted aluminium system with movable and tiltable brackets
- Wall-mounted or floor-mounted motors
- Safety switch

### Recommended additional options

- Control button
- Front
- Hose cover/cover panels
- Sink (Not 6303L/6313L)
- Drawer (not 6303L/6313L)
- Rear edge trim
- Top board
- Hob

### Useful information

- Fittings for top board and fronts enclosed
- The top board's depth must be 15 mm shallower than adjoining top boards (to provide a gap for tiles and movement)
- Width of the top board = width of the lift
- Sinks with a maximum height of 120 mm can be integrated (Not 6303L/6313L)
- Electronics and motor system "Plug and Play"
- Width of front = width of lift - 4 mm  
Height of front: 6303H/6313H = 103 mm, 6303L/6313L = 40 mm  
Fittings enclosed
- Cover panels can hide installations under the worktop  
2 pcs, height 438 mm, thickness 12-20 mm

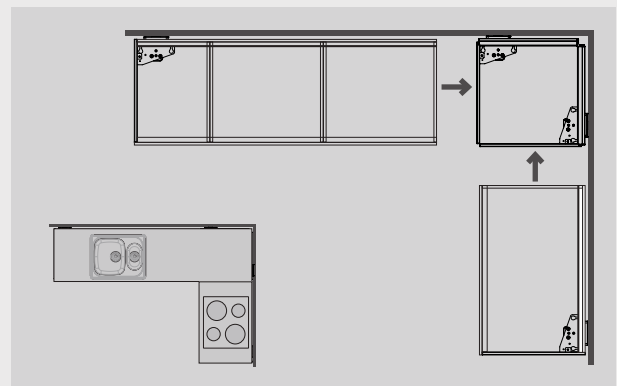

The corner module is equipped with two motors and can be used as one unit. Supplement with Plus modules to obtain the desired length on the left and right wings. Sink and hob can be positioned in the plus modules.

Specify the position of the drawers, sink and hob  
The worktop is prepared in the factory. Drawers are mounted and sides assembled to facilitate the final mounting on the spot.

**WALL-MOUNTED**

6303H



6303L



**FLOOR-MOUNTED**

6313H



6313L



**Specifications**

<b>Mounting</b>	Wall or floor
<b>Corner solution</b>	90° front edge, 90° wall
<b>Height adjustment</b>	Motorised, steplessly adjustable 300 mm (700-1000 mm excl. top board)
<b>Speed</b>	30 mm / sec.
<b>Manoeuvring</b>	Recessed mounted button or radio control
<b>Safety</b>	The safety strip is placed under the front edge of the worktop. If anything touches the safety strip, the lifting unit stops
<b>Electricity connection</b>	Plug for 230 V, 2 x 5A
<b>Plumbing connections</b>	Connection is made with flexible hoses
<b>Lifting power</b>	100 kg
<b>IP Class</b>	IP 20
<b>Frame depth</b>	560-590 mm from wall
<b>Front height</b>	40 or 103 mm
<b>Dimensions cover panels</b>	2 pcs, height 438 mm, thickness 12-20 mm
<b>Width top board</b>	Width = width of the lift
<b>Depth top board</b>	565-630 mm (15 mm shallower than worktops on fixed cabinets)
<b>Gap to the side to wall/adjoining cabinet</b>	5 mm
<b>Gap to wall (for tiling)</b>	15 mm
<b>Tiling</b>	From 700 mm above floor (alternatively all the way down to the floor)
<b>Delivery modules</b>	Ready-mounted worktop incl. safety switch, motors
<b>Fittings enclosed</b>	Bracket for fronts and top board
<b>Material specifications</b>	Aluminium frame
<b>Guarantee</b>	2 years
	<b>CE</b>

**Measurement data**

(mm)

**WALL-MOUNTED: 6303H/6303L**

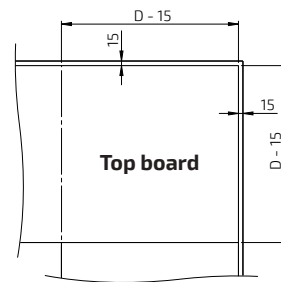
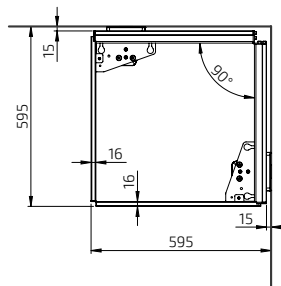
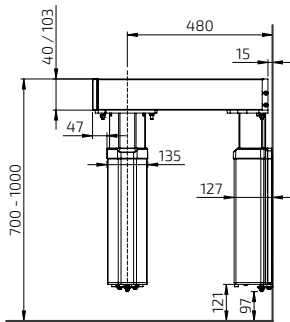

**D = Depth of top board on fixed cabinets**

**FLOOR-MOUNTED: 6313H / 6313L**

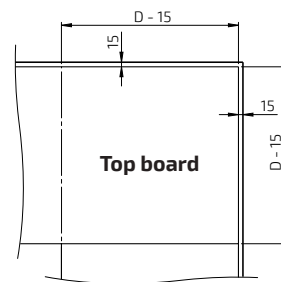
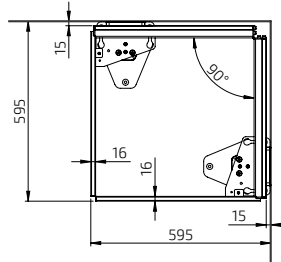
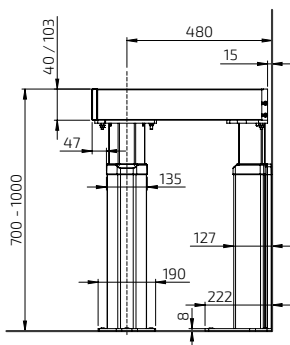

**D = Depth of top board on fixed cabinets**

**BASELIFT Corner 6303HA - Wall-mounted**

Lifting unit 59.5 x 59.5 cm  
 For 103 mm front  
 Frame depth 56.0 - 59.0 cm  
 2 motors  
 Safety switch



**BASELIFT Corner 6313HA - Floor-mounted**

Lifting unit 59.5 x 59.5 cm  
 For 103 mm front  
 Frame depth 56.0 - 59.0 cm  
 2 motors  
 Safety switch



	Width (cm)	Art. no.
	59.5	6303HA-595

	Width (cm)	Art. no.
	59.5	6313HA-595

**Plus module Left 6305HA, 40.0-100.0 cm**



40.0	6305HA-040
50.0	6305HA-050
60.0	6305HA-060
70.0	6305HA-070
80.0	6305HA-080
90.0	6305HA-090
100.0	6305HA-100

**Plus module Left 6315HA, 40.0 - 100.0 cm**



40.0	6315HA-040
50.0	6315HA-150
60.0	6315HA-060
70.0	6315HA-070
80.0	6315HA-080
90.0	6315HA-090
100.0	6315HA-100

**Plus module Left 6305HA, 110.0-180.0 cm**



110.0	6305HA-110
120.0	6305HA-120
130.0	6305HA-130
140.0	6305HA-140
150.0	6305HA-150
160.0	6305HA-160
170.0	6305HA-170
180.0	6305HA-180

**Plus module Left 6315HA, 110.0 - 180.0 cm**



110.0	6315HA-110
120.0	6315HA-120
130.0	6315HA-130
140.0	6315HA-140
150.0	6315HA-150
160.0	6315HA-160
170.0	6315HA-170
180.0	6315HA-180

**Plus module Left 6305HA, 190.0-240.0 cm**



190.0	6305HA-190
200.0	6305HA-200
210.0	6305HA-210
220.0	6305HA-220
230.0	6305HA-230
240.0	6305HA-240

**Plus module Left 6315HA, 190.0 - 240.0 cm**



190.0	6315HA-190
200.0	6315HA-200
210.0	6315HA-210
220.0	6315HA-220
230.0	6315HA-230
240.0	6315HA-240

**Plus module Right 6306HA, 40.0-100.0 cm**



40.0	6306HA-040
50.0	6306HA-050
60.0	6306HA-060
70.0	6306HA-070
80.0	6306HA-080
90.0	6306HA-090
100.0	6306HA-100

**Plus module Right 6316HA, 40.0 - 100.0 cm**



40.0	6316HA-040
50.0	6316HA-050
60.0	6316HA-160
70.0	6316HA-070
80.0	6316HA-080
90.0	6316HA-090
100.0	6316HA-100

**Plus module Right 6306HA, 110.0 - 180.0 cm**



110.0	6306HA-110
120.0	6306HA-120
130.0	6306HA-130
140.0	6306HA-140
150.0	6306HA-150
160.0	6306HA-160
170.0	6306HA-170
180.0	6306HA-180

**Plus module Right 6316HA, 110.0 - 180.0 cm**



110.0	6316HA-110
120.0	6316HA-120
130.0	6316HA-130
140.0	6316HA-140
150.0	6316HA-150
160.0	6316HA-160
170.0	6316HA-170
180.0	6316HA-180

**Plus module Right 6306HA, 190.0 - 180.0 cm**





















190.0	6306HA-190
200.0	6306HA-200
210.0	6306HA-210
220.0	6306HA-220
230.0	6306HA-230
240.0	6306HA-240

**Plus module Right 6316HA, 190.0 - 240.0 cm**



190.0	6316HA-190
200.0	6316HA-200
210.0	6316HA-210
220.0	6316HA-220
230.0	6316HA-230
240.0	6316HA-240



	<p><b>Control button in ALU-design</b> Wired, for recessed mounting Dimensions: 82 x 82 x 17 mm</p>	<p>61320</p>		<p><b>Cutlery compartment</b> Fits 30.0 cm wide drawer 463-030 Fits 40.0 cm wide drawer 463-040 Fits 50.0 cm wide drawer 463-050 Fits 60.0 cm wide drawer 463-060 Fits 80.0 cm wide drawer 463-080</p>	
	<p><b>Control button, Mini</b> Wired, for recessed mounting Diameter: 20 mm</p>	<p>61318</p>		<p><b>Safety strip</b> Used if pinch protection is desired on the gable end (by an open side). Length: 370 mm, Height: 10 mm</p>	<p>61430</p>
 <p>Radio control for 1 lift Radio control for 2-5 lifts</p>	<p><b>Radio control - Hand control</b> Dimensions: 38 x 110 x 10 mm For one lift 61385 For two lifts 61387 For three lifts 61388 For four lifts 61389 For five lifts 61390</p>			<p><b>Safety panel, short end</b> Used when the worktop lift's underside passes over adjoining furnishings. Height: 263 mm, Depth: 400 mm <b>For a worktop lift with cover panels</b> Left 61442 Right 61443</p>	
	<p><b>Power Socket, Black</b> Diameter 68 mm, Drilling: 56 mm Installation depth 45 mm Cable length 2 m Earthed (EU 2-pin) 61333 Earthed (UK 3-pin) 61333.UK</p>			<p><b>Safety panel, short end</b> Used when the worktop lift's underside passes over adjoining furnishings. Height: 263 mm, Depth: 545 mm <b>For a worktop lift without cover panels</b> Left 61444 Right 61445</p>	
	<p><b>Socket, ALU-design</b> Earthed socket 230 V with flap cover. Dimensions: 82 x 82 x 17 mm Earthed (EU 2-pin) 61330</p>			<p><b>Hob cover under worktop lift</b> Provides a smooth underside. Used under the hob. White-lacquered metal RAL 9003 60.0 cm 6266-060 70.0 cm 6266-070 80.0 cm 6266-080 90.0 cm 6266-090 100.0 cm 6266-100</p>	
	<p><b>Power switch, ALU-design</b> For lighting, for example. The button has a sign for optional marking. Dimensions: 82 x 82 x 17 mm</p>	<p>61331</p>			
	<p><b>Multi-compartment frame, ALU-design</b> Collects power socket, power switch or control buttons in a multi-compartment frame. Two-compartment frame: 153 x 82 x 9 mm 61352 Three-compartment frame: 225 x 82 x 9 mm 61353</p>			<p><b>Cover panels</b> Used to cover installations under the worktop. 12 mm white melamine, 2 pcs height 438 mm 2 pcs are required for lengths over 2400 mm 6260-240</p>	
	<p><b>Safety lock</b> Prevents unauthorised use. Dimensions: 23 x 9 mm</p>	<p>61360</p>		<p><b>Fittings set for cover panels</b> Used to mount cover panels that conceal installations under the worktop. Colour: Alu-grey RAL 9006 2 pcs are required for lengths over 2400 mm 6260-005</p>	
	<p><b>Front</b> Optional length, 20.0-340.0 cm Replace xxx with cm when ordering. Example, 385H-040-01 for 40.0 cm Height: 103 mm Lacquered aluminium, white RAL 9003 385H-xxx-01 Anodised aluminium 385H-xxx-06</p>			<p><b>Hose cover</b> The hose cover is mounted anywhere under the worktop, (next to motors, if applicable) to provide a neat coverage of hoses when the cover panels are not in use. Fittings are included. Width: 410 mm, Depth: 200 mm White plastic 61504-01 Grey plastic 61504-06</p>	
	<p><b>Integrated drawer with full extension and soft-close or push-to-open function</b> Depth: 470 mm, height: 85 mm Colour: Anthracite (RAL 9004) 30.0 cm 465H-030 40.0 cm 465H-040 50.0 cm 465H-050 60.0 cm 465H-060 80.0 cm 465H-080 30.0 cm - Push-to-open function 466H-030 40.0 cm - Push-to-open function 466H-040 50.0 cm - Push-to-open function 466H-050 60.0 cm - Push-to-open function 466H-060 80.0 cm - Push-to-open function 466H-080</p>			<p><b>Rear edge trim in aluminium for top board</b> Mounted behind top board. Brushed aluminium Height above top board: 20 mm Thickness behind top board: 3 mm (per metre) 6943-06</p>	
				<p><b>Height-adjustment kit</b> Used to change stroke after installation. Contains programming box and memory adapter. 61400</p>	

**BASELIFT Corner 6303LA - Wall-mounted**

Lifting unit 59.5 x 59.5 cm  
 For 40 mm front  
 Frame depth 56.0 - 59.0 cm  
 2 motors  
 Safety switch



**BASELIFT Corner 6313LA - Floor-mounted**

Lifting unit 59.5 x 59.5 cm  
 For 40 mm front  
 Frame depth 56.0 - 59.0 cm  
 2 motors  
 Safety switch



	Width (cm)	Art. no.
	59.5	6303LA-595

	Width (cm)	Art. no.
	59.5	6313LA-595

**Plus module Left 6305LA, 40.0-100.0 cm**



40.0	6305LA-040
50.0	6305LA-050
60.0	6305LA-060
70.0	6305LA-070
80.0	6305LA-080
90.0	6305LA-090
100.0	6305LA-100

**Plus module Left 6315LA, 40.0 - 100.0 cm**



40.0	6315LA-040
50.0	6315LA-150
60.0	6315LA-060
70.0	6315LA-070
80.0	6315LA-080
90.0	6315LA-090
100.0	6315LA-100

**Plus module Left 6305LA, 110.0-180.0 cm**



110.0	6305LA-110
120.0	6305LA-120
130.0	6305LA-130
140.0	6305LA-140
150.0	6305LA-150
160.0	6305LA-160
170.0	6305LA-170
180.0	6305LA-180

**Plus module Left 6315LA, 110.0 - 180.0 cm**



110.0	6315LA-110
120.0	6315LA-120
130.0	6315LA-130
140.0	6315LA-140
150.0	6315LA-150
160.0	6315LA-160
170.0	6315LA-170
180.0	6315LA-180

**Plus module Left 6305LA, 190.0-240.0 cm**



190.0	6305LA-190
200.0	6305LA-200
210.0	6305LA-210
220.0	6305LA-220
230.0	6305LA-230
240.0	6305LA-240

**Plus module Left 6315LA, 190.0 - 240.0 cm**



190.0	6315LA-190
200.0	6315LA-200
210.0	6315LA-210
220.0	6315LA-220
230.0	6315LA-230
240.0	6315LA-240

**Plus module Right 6306LA, 40.0 - 100.0 cm**



40.0	6306LA-040
50.0	6306LA-050
60.0	6306LA-060
70.0	6306LA-070
80.0	6306LA-080
90.0	6306LA-090
100.0	6306LA-100

**Plus module Right 6316LA, 40.0 - 100.0 cm**



40.0	6316LA-040
50.0	6316LA-050
60.0	6316LA-160
70.0	6316LA-070
80.0	6316LA-080
90.0	6316LA-090
100.0	6316LA-100

**Plus module Right 6306LA, 110.0 - 180.0 cm**



110.0	6306LA-100
120.0	6306LA-120
130.0	6306LA-130
140.0	6306LA-140
150.0	6306LA-150
160.0	6306LA-160
170.0	6306LA-170
180.0	6306LA-180

**Plus module Right 6316LA, 110.0 - 180.0 cm**



110.0	6316LA-110
120.0	6316LA-120
130.0	6316LA-130
140.0	6316LA-140
150.0	6316LA-150
160.0	6316LA-160
170.0	6316LA-170
180.0	6316LA-180

**Plus module Right 6306LA, 190.0 - 240.0 cm**















190.0	6306LA-190
200.0	6306LA-200
210.0	6306LA-210
220.0	6306LA-220
230.0	6306LA-230
240.0	6306LA-240

**Plus module Right 6316LA, 190.0 - 240.0 cm**



190.0	6316LA-190
200.0	6316LA-200
210.0	6316LA-210
220.0	6316LA-220
230.0	6316LA-230
240.0	6316LA-240

 <p><b>Control button, Mini</b> Wired, for recessed mounting Diameter: 20 mm</p>	<p>61318</p>	 <p><b>Safety strip</b> Used if pinch protection is desired on the gable end (by an open side). Length: 370 mm Height: 10 mm</p>	<p>61430</p>
 <p><b>Radio control - Hand control</b> Dimensions: 38 x 110 x 10 mm</p> <p>For one lift 61385</p> <p>For two lifts 61387</p> <p>For three lifts 61388</p> <p>For four lifts 61389</p> <p>For five lifts 61390</p> <p>Radio control for 1 lift</p> <p>Radio control for 2-5 lifts</p>		 <p><b>Safety panel, short end</b> Used when the worktop lift's underside passes over adjoining interior fittings. Height: 263 mm, Depth: 400 mm</p> <p><b>For a worktop lift with cover panels</b></p> <p>Left 61442</p> <p>Right 61443</p>	
 <p><b>Safety lock</b> Prevents unauthorised use. Dimensions: 23 x 9 mm</p>	<p>61360</p>	 <p><b>Safety panel, short end</b> Used when the worktop lift's underside passes over adjoining furnishings. Height: 263 mm, Depth: 545 mm</p> <p><b>For a worktop lift without cover panels</b></p> <p>Left 61444</p> <p>Right 61445</p>	
 <p><b>Front, white-lacquered aluminium</b> Replace xxx with cm when ordering. Example, 385L-040-01 for 40.0 cm</p> <p>Lacquered aluminium, white RAL 9003 Height: 40 mm</p> <p>Optional length, 20.0-340.0 cm</p>	<p>385L-xxx-01</p>	 <p><b>Hob cover under worktop lift</b> Provides a smooth underside. Used under the hob.</p> <p>White-lacquered metal RAL 9003</p> <p>60.0 cm 6266-060</p> <p>70.0 cm 6266-070</p> <p>80.0 cm 6266-080</p> <p>90.0 cm 6266-090</p> <p>100.0 cm 6266-100</p>	
 <p><b>Front, anodised aluminium</b> Replace xxx with cm when ordering. Example, 385L-040-06 for 40.0 cm</p> <p>Anodised aluminium Height: 40 mm</p> <p>Optional length, 20.0-340.0 cm</p>	<p>385L-XXX-06</p>	 <p><b>Cover panels</b> Used to cover installations under the worktop.</p> <p>Length is adapted to worktop lift's length.</p> <p>12 mm white melamine, 2 pcs height 438 mm</p> <p>2 pcs are required for lengths over 2400 mm</p>	<p>6260-240</p>
 <p><b>Fittings set for cover panels</b> Used to mount cover panels that conceal installations under the worktop.</p> <p>Colour: Alu-grey RAL 9006</p> <p>2 pcs are required for lengths over 2400 mm</p>	<p>6260-005</p>	 <p><b>Rear edge trim in aluminium for top board</b> Mounted behind top board. Brushed aluminium Height above top board: 20 mm Thickness behind top board: 3 mm (per metre)</p>	
		 <p><b>Height-adjustment kit</b> Used to change stroke after installation. Contains programming box and memory adapter.</p>	<p>61400</p>



# SIDELIFT 6400

Floor-mounted, motorised, straight worktop lift with side motors

SIDELIFT 6400 is a straight, motorised worktop lift. Cabinets can be hung under the entire lift or under certain sections. Powerful motors (400 kg lifting power) are located on the short sides.

The motors work steplessly and adjust the worktop quickly and quietly to the desired height. The lift is equipped with a reliable safety system that guarantees safe operation without any risk of pinching. The lift is prepared in the factory to facilitate easy installation.

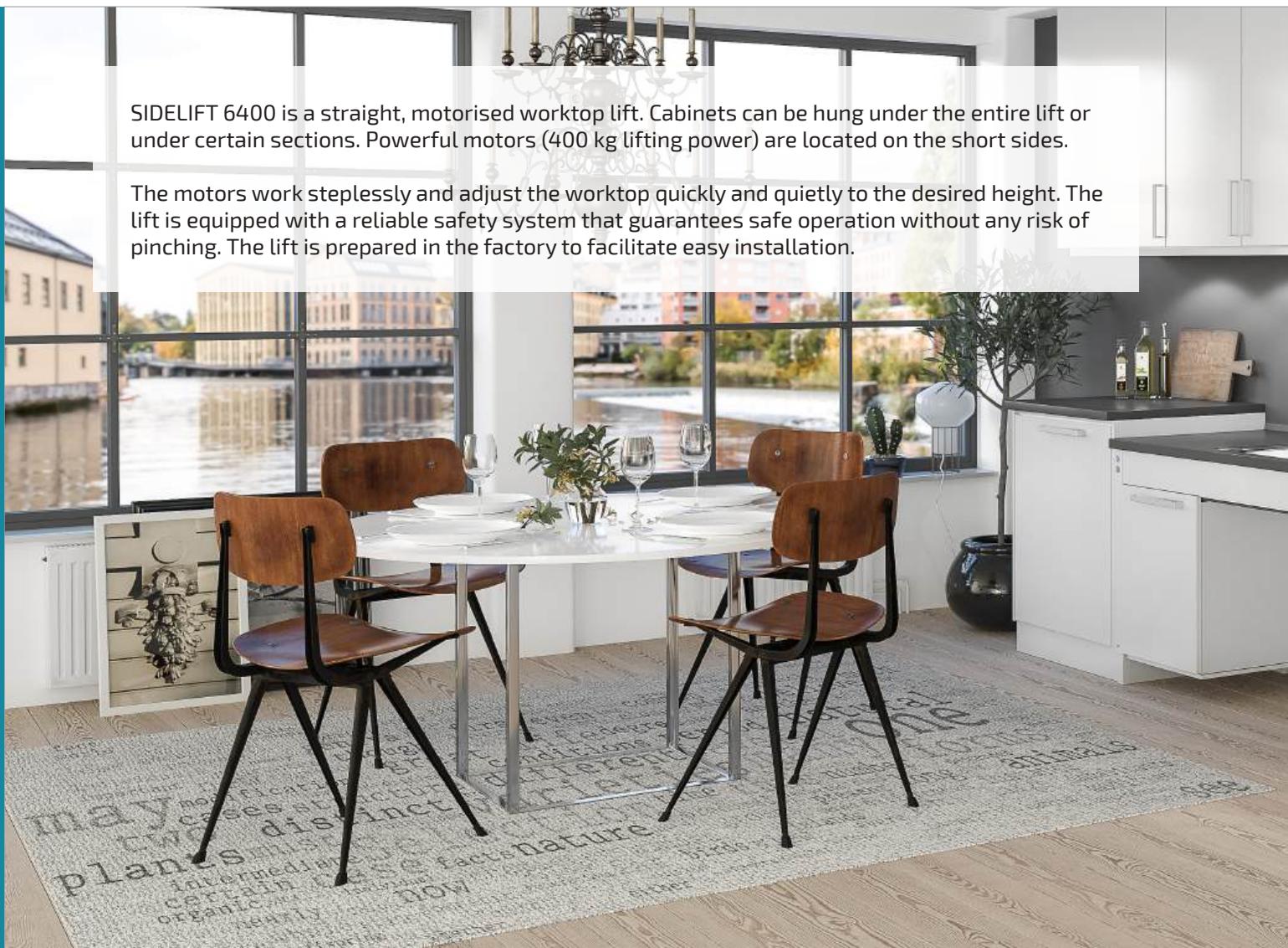

SIDELIFT creates an ergonomic kitchen worktop which everyone can use comfortably. The motors take up minimal space and there is ample room for storage in the hanging cabinets.





If needs change, the cabinets can easily be removed to provide space for work done when sitting down. The cabinets can be re-mounted just as easily.



### Functions and advantages

- Motorised, straight worktop lift with side motors
- Cabinets can be hung under the entire worktop or under certain parts
- Height-adjustable 70-100 cm above the floor (excl. top board)
- 400 kg lifting power
- Safety switch under cabinets and where there are spaces for knees
- Control button, Mini located in motor units

### Standard equipment

- Factory-mounted aluminium system
- Floor-mounted motors
- Control button

### Recommended additional options

- Hanging cabinets
- Front
- Safety plates (under hanging cabinets)
- Top board
- Sink
- Hob

### Useful information

- Fittings for top board enclosed
- Width of the top board = width of the lift
- The top board's depth must be 15 mm shallower than adjoining top boards (to provide a gap for tiles and movement)
- Sink bowls with a maximum height of 120 mm can be integrated
- Electronics and motor system "Plug and Play"
- Width of front = width of lift -94 mm  
Height of front = 103 mm  
Fittings enclosed
- Cover panels can hide installations under the worktop  
Width = width of lift -410 mm  
2 pcs height 438 mm, thickness 12-20 mm

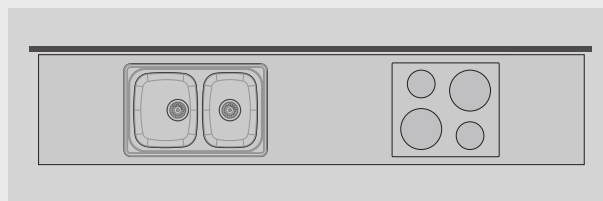

#### Specify the position of cabinets, sink and hob

The worktop is prepared in the factory to facilitate final assembly on site.



## Specifications

<b>Mounting</b>	Floor
<b>Height adjustment</b>	Motorised, steplessly adjustable 300 mm (700-1000 mm excl. top board)
<b>Speed</b>	20 mm / sec.
<b>Manoeuvring</b>	Control button, Mini is located in the motor units (left and right side)
<b>Safety</b>	There are safety switches under the cabinet and under the front in spaces for knees. The function of the safety switch is to stop the movement if it comes into contact with any object.
<b>Electricity connection</b>	Plug for 230 V, 2 x 5A
<b>Plumbing connections</b>	Connection is made with flexible hoses
<b>Lifting power</b>	400 kg
<b>IP Class</b>	IP 20
<b>Frame depth</b>	561 mm from wall
<b>Front height</b>	103 mm
<b>Dimensions cover panels</b>	Width = Width of lift -410 mm 2 pcs Height 438 mm Thickness 12 mm
<b>Width top board</b>	Width = width of the lift
<b>Depth top board</b>	15 mm shallower than worktops on fixed cabinets
<b>Gap to the side to wall/adjoining cabinet</b>	5 mm
<b>Gap to wall (for tiling)</b>	15 mm
<b>Tiling</b>	From 700 mm above floor (alternatively all the way down to the floor)
<b>Delivery modules</b>	1 package with motor units. 1 package with length-dependent beams
<b>Material specifications</b>	Motor units in lacquered steel (S235JRG2). Aluminium beams
<b>Guarantee</b>	2 years
	CE

## Measurement data

(mm)

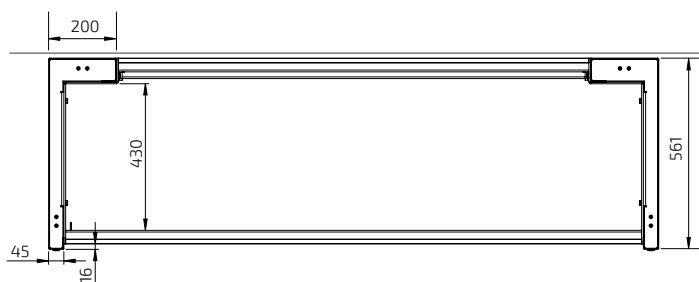
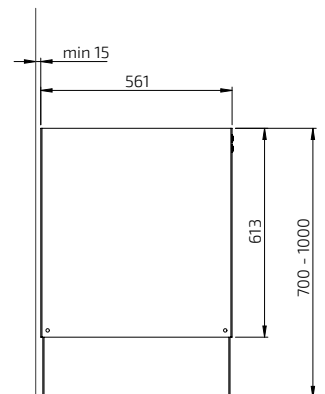
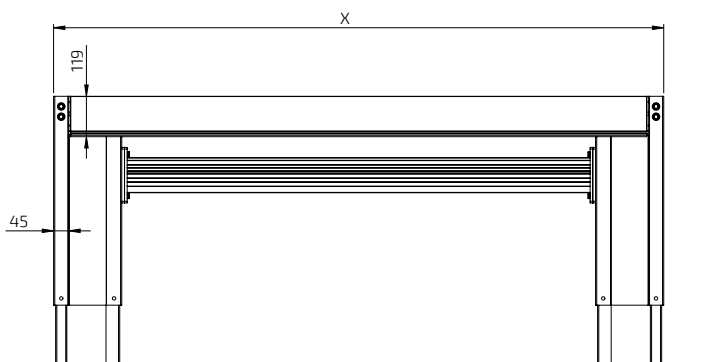





With a SIDELIFT in your kitchen, the kitchen of the future is already here! An ergonomic kitchen worktop with generous storage space that can easily be height-adjusted.



If your needs change, the cabinets can easily be removed to provide space for work done when sitting down. The cabinets can be re-mounted just as easily.



Safety systems, in the form of safety plates under cabinets and safety strips where there are spaces for knees, stop all movement if any object comes in contact with the switches.



Inset sink with shallow sink bowl and hob can be integrated.



The hanging cabinets are equipped with two fully-extendable, soft-close drawers.



Hanging cabinets with waste sorting bins are available in widths 40-80 cm.



**SIDELIFT 6400H**

- White RAL 9003
- Incl. control button Mini in the motor units (left and right side)
- Supplement with front that conceals the lifting frame



Width (cm)	Art. no.	Width (cm)	Art. no.
99.0	6400HA-099-01	219.0	6400HA-219-01
109.0	6400HA-109-01	229.0	6400HA-229-01
119.0	6400HA-119-01	239.0	6400HA-239-01
129.0	6400HA-129-01	249.0	6400HA-249-01
139.0	6400HA-139-01	259.0	6400HA-259-01
149.0	6400HA-149-01	269.0	6400HA-269-01
159.0	6400HA-159-01	279.0	6400HA-279-01
169.0	6400HA-169-01	289.0	6400HA-289-01
179.0	6400HA-179-01	299.0	6400HA-299-01
189.0	6400HA-189-01	309.0	6400HA-309-01
199.0	6400HA-199-01	319.0	6400HA-319-01
209.0	6400HA-209-01	329.0	6400HA-329-01

**SIDELIFT 6400H**

- Anthracite RAL 9004
- Incl. manoeuvre button Mini in the motor units (left and right side)
- Supplement with front that conceals the lifting frame



99.0	6400HA-099-07	219.0	6400HA-219-07
109.0	6400HA-109-07	229.0	6400HA-229-07
119.0	6400HA-119-07	239.0	6400HA-239-07
129.0	6400HA-129-07	249.0	6400HA-249-07
139.0	6400HA-139-07	259.0	6400HA-259-07
149.0	6400HA-149-07	269.0	6400HA-269-07
159.0	6400HA-159-07	279.0	6400HA-279-07
169.0	6400HA-169-07	289.0	6400HA-289-07
179.0	6400HA-179-07	299.0	6400HA-299-07
189.0	6400HA-189-07	309.0	6400HA-309-07
199.0	6400HA-199-07	319.0	6400HA-319-07
209.0	6400HA-209-07	329.0	6400HA-329-07

**Recommended accessories**

**Front that conceals the lifting frame**

**Hanging cabinets**

**Safety plates (under cabinets)**

**Cover panels**



**Hanging cabinet with drawers**  
The cabinet has a large drawer and a smaller inner drawer for cutlery and utensils.

Fully extendable with soft-close.  
Frame height 510 mm  
Frame depth: 470 mm

Frame in white melamine.  
White-lacquered door (NCS 0500-N)

30.0 cm	760-030-01
40.0 cm	760-040-01
50.0 cm	760-050-01
60.0 cm	760-060-01
70.0 cm	760-070-01
80.0 cm	760-080-01



**Mini cabinet on wheels with drawer and inner drawer, fully extendable with soft-close**

The cabinet is opened by pulling out the drawer.

Width: 400 mm  
Height: 574 mm  
Depth incl. grip handle: 495 mm

Top board in white compact laminate with integrated grip handle.

Frame in white melamine.  
White-lacquered door (NCS 0500-N)

770-040-01



**Hanging cabinet with waste sorting bins, 40 cm**  
The cabinet is fitted with 2 waste bins. The upper part has an inner drawer for cutlery and utensils.

Fully extendable with soft-close.  
Frame height 510 mm  
Frame depth: 470 mm

Waste bins (litre):  
1 pc 17 litre, 1 pc 11 litre

Frame in white melamine.  
White-lacquered door (NCS 0500-N)

761-040-01



**Mini cabinet on wheels with waste sorting and inner drawer, fully extendable with soft-close**

The cabinet is opened by pulling out the drawer. The bottom with the waste bins is included.

Included bins:  
1 pc 11 liter 1 pc 17 liter

Width: 400 mm  
Height: 574 mm  
Depth incl. grip handle: 495 mm

Top board in white compact laminate with integrated grip handle.

Frame in white melamine.  
White-lacquered door (NCS 0500-N)

771-040-01



**Hanging cabinet with waste sorting bins, 60 cm**  
The cabinet is fitted with 4 waste bins. The upper part has an inner drawer for cutlery and utensils.

Fully extendable with soft-close.  
Frame height 510 mm  
Frame depth: 470 mm

Waste bins (litre):  
1 pc 17 litre, 1 pc 11 litre, 1 pc 8 litre, 1 pc 5 litre

Frame in white melamine.  
White-lacquered door (NCS 0500-N)

761-060-01



**Cutlery compartment for inner drawer**

Practical compartments that can be adapted to suit your needs.

Fits 30.0 cm wide inner drawer	460-030
Fits 40.0 cm wide inner drawer	460-040
Fits 50.0 cm wide inner drawer	460-050
Fits 60.0 cm wide inner drawer	460-060
Fits 70.0 cm wide inner drawer	460-070
Fits 80.0 cm wide inner drawer	460-080



**Hanging cabinet under sink, 60 cm**  
The cabinet is fitted with 4 waste bins.

Fully extendable with soft-close.  
Frame height 510 mm  
Frame depth: 470 mm

Waste bins (litre):  
1 pc 17 litre, 1 pc 11 litre, 1 pc 8 litre, 1 pc 5 litre

Frame in white melamine.  
White-lacquered door (NCS 0500-N)

762-060-01



**Hanging cabinet under sink, 80 cm**  
The cabinet is fitted with 6 waste bins.

Fully extendable with soft-close.  
Frame height 510 mm  
Frame depth: 470 mm

Waste bins (litre):  
1 pc 17 litre, 1 pc 11 litre, 2 pcs 8 litre, 2 pcs 5 litre

Frame in white melamine.  
White-lacquered door (NCS 0500-N)









762-080-01

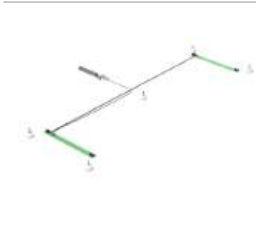

**Fittings for hanging cabinet**

One set per cabinet.

6250-001

 <p>Front for lift frame</p>	<p><b>Front that conceals the lift frame</b></p> <p>Total length: Width of lift -94 mm</p> <p>Replace xxx with cm when ordering. For example, 385H-040-01 for 40.0 cm</p> <p>Height: 103 mm</p> <table border="1"> <tr> <td>Lacquered aluminium, white RAL 9003</td> <td>385H-xxx-01</td> </tr> <tr> <td>Lacquered ALU, Anthracite RAL 9004</td> <td>385H-xxx-07</td> </tr> <tr> <td>Lacquered ALU, Black RAL 9004</td> <td>385H-xxx-10</td> </tr> <tr> <td>Anodised ALU</td> <td>385H-xxx-06</td> </tr> </table>	Lacquered aluminium, white RAL 9003	385H-xxx-01	Lacquered ALU, Anthracite RAL 9004	385H-xxx-07	Lacquered ALU, Black RAL 9004	385H-xxx-10	Anodised ALU	385H-xxx-06					
Lacquered aluminium, white RAL 9003	385H-xxx-01													
Lacquered ALU, Anthracite RAL 9004	385H-xxx-07													
Lacquered ALU, Black RAL 9004	385H-xxx-10													
Anodised ALU	385H-xxx-06													
	<p><b>Safety plates SIDELIFT 6400</b></p> <p>The function of the safety plate is to stop the movement of the cabinet if the plate comes in contact with any object. Choose a plate that suits the width of the cabinet.</p> <p>Colour: White Thickness: 12 mm Depth: 466 mm</p> <table border="1"> <tr> <td>30.0 cm width</td> <td>6253-030-01</td> </tr> <tr> <td>40.0 cm width</td> <td>6253-040-01</td> </tr> <tr> <td>50.0 cm width</td> <td>6253-050-01</td> </tr> <tr> <td>60.0 cm width</td> <td>6253-060-01</td> </tr> <tr> <td>70.0 cm width</td> <td>6253-070-01</td> </tr> <tr> <td>80.0 cm width</td> <td>6253-080-01</td> </tr> </table>	30.0 cm width	6253-030-01	40.0 cm width	6253-040-01	50.0 cm width	6253-050-01	60.0 cm width	6253-060-01	70.0 cm width	6253-070-01	80.0 cm width	6253-080-01	
30.0 cm width	6253-030-01													
40.0 cm width	6253-040-01													
50.0 cm width	6253-050-01													
60.0 cm width	6253-060-01													
70.0 cm width	6253-070-01													
80.0 cm width	6253-080-01													
	<p><b>Safety package for safety plate of your own design</b></p> <p>The safety package contains micro-switches and cables for mounting on your own board. Instructions with milling dimensions enclosed.</p> <p>The dimensions of the board must be: Thickness: 12-16 mm Width: 400 - 800 mm Depth: 466 mm</p>	<table border="1"> <tr> <td></td> <td>6253-00</td> </tr> </table>		6253-00										
	6253-00													
	<p><b>Radio control - Hand control</b></p> <p>Dimensions: 38 x 110 x 10 mm</p> <p>For one lift</p>	<table border="1"> <tr> <td></td> <td>61385</td> </tr> </table>		61385										
	61385													
	<p><b>Cover panels</b></p> <p>Used to cover installations under the worktop.</p> <p>12 mm white melamine 2 pcs height 438 mm 2 panels are needed for lifts longer than 2490 mm</p>	<table border="1"> <tr> <td></td> <td>6262-240-01</td> </tr> </table>		6262-240-01										
	6262-240-01													
	<p><b>Fittings set for cover panels, Sidelift</b></p> <p>Used to mount cover panels that conceal installations under the worktop.</p> <p>Colour: White RAL 9003</p>	<table border="1"> <tr> <td></td> <td>6260-008</td> </tr> </table>		6260-008										
	6260-008													
	<p><b>Rear edge trim in aluminium for top board</b></p> <p>Mounted behind the top board. Brushed aluminium Height above top board: 20 mm Thickness behind top board: 3 mm (per metre)</p>	<table border="1"> <tr> <td></td> <td>6943-06</td> </tr> </table>		6943-06										
	6943-06													
	<p><b>Height-adjustment kit</b></p> <p>Used to change stroke after installation. Contains programming box and memory adapter.</p>	<table border="1"> <tr> <td></td> <td>61400</td> </tr> </table>		61400										
	61400													

# MANULIFT 6350

Wall-mounted manually height-adjustable worktop unit, cranked winding handle

MANULIFT 6350H is a manually adjustable worktop unit.

Under the worktop, space is left for the knees and legs. Installations under the worktop, (brackets, water, sewers), can be concealed by telescopic cover panels which gives the kitchen a neat look.

30 cm stepless height adjustment by a cranked winding handle.  
The lift is prepared in the factory to facilitate easy installation.

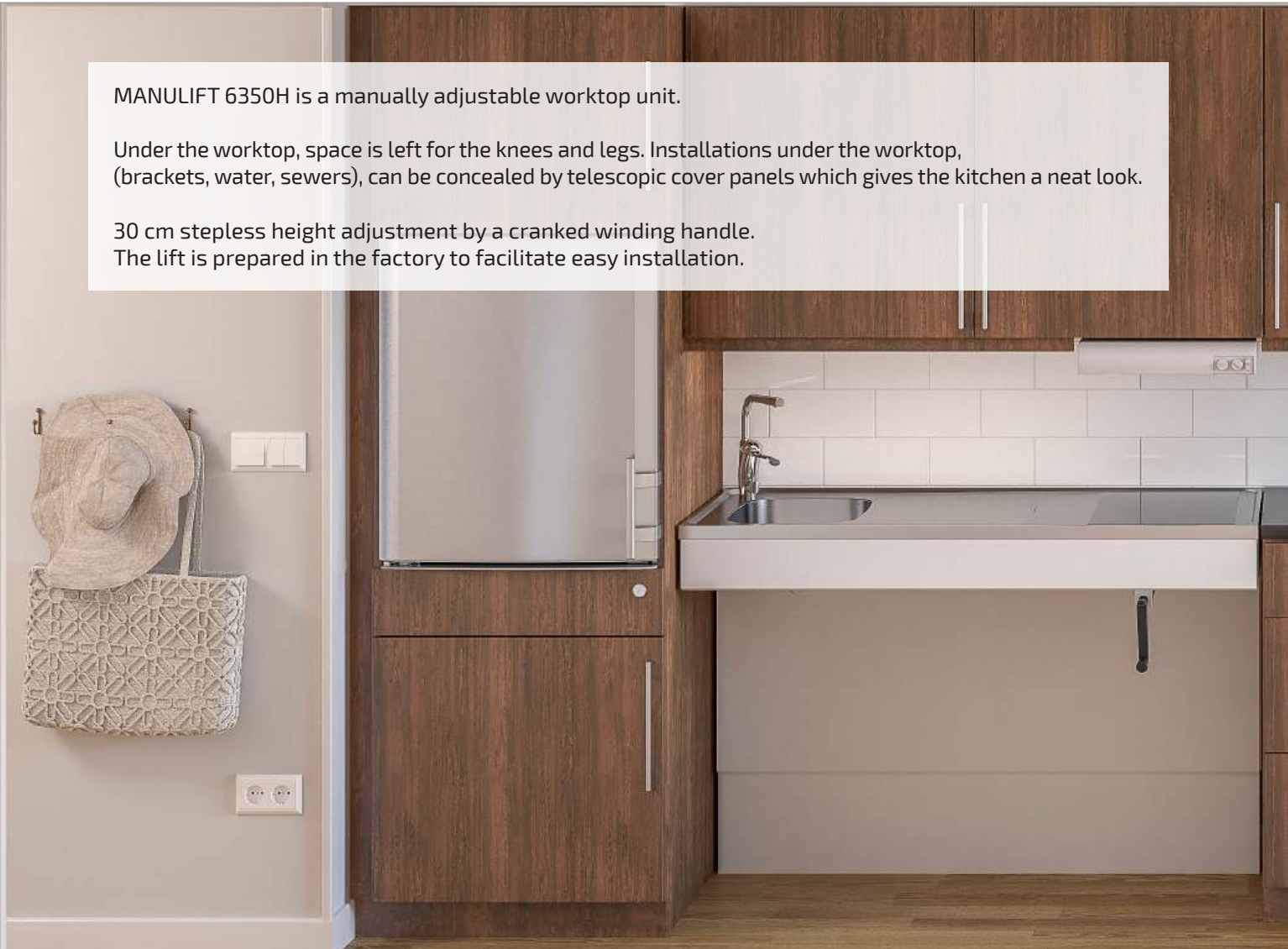

MANULIFT 6350 is a cost effective and flexible solution, 30 cm stepless height adjustment by a cranked winding handle.





The winding handle can be folded when not in use.



### Functions and advantages

- Height adjustment by a cranked winding handle
- Height-adjustable 70-100 cm above the floor (excl. top board)
- The frame depth is adjustable 56-59 cm to fit adjoining cabinet
- The upper part of the lifting system is delivered ready-mounted. The sides are pre-assembled and adjustable sideways to suit the sink, hob and drawers
- The lifting system is adjustable at an angle to compensate for an inclined wall
- 10 cm free space under the wall brackets for electrical installations and piping

### Standard equipment

- Factory-mounted aluminium system with movable and tiltable brackets
- Wall brackets and cranked winding handle

### Recommended additional options

- |                           |                  |
|---------------------------|------------------|
| - Front                   | - Rear edge trim |
| - Hose cover/cover panels | - Top board      |
| - Sink                    | - Hob            |
| - Drawer                  |                  |

### Useful information

- Fittings for top board and fronts enclosed
- *The top board's depth must be 15 mm shallower than adjoining top boards (to provide a gap for tiles and movement)*
- Width of the top board = width of the lift
- Sink bowls with a maximum height of 120 mm can be integrated
- Width of front = width of lift -4 mm  
Height of front: 103 mm  
Fittings enclosed
- Cover panels can hide installations under the worktop  
2 pcs width = width of lift -10 mm, height 438 mm, thickness 12-20 mm

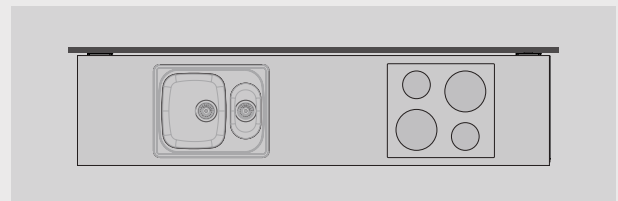

### Specify the location of drawers, sink and hob

The worktop is prepared in the factory. Drawers are mounted and sides assembled to facilitate the final mounting on the spot.

6350H



### Specifications

<b>Mounting</b>	Wall
<b>Height adjustment</b>	300 mm stepless height adjustment by a cranked winding handle
<b>Number of turns / cm height adjustment</b>	3,3
<b>Plumbing connections</b>	Connection is made with flexible hoses
<b>Maximum load</b>	100 kg
<b>Frame depth</b>	560-590 mm from wall
<b>Front height</b>	103 mm
<b>Dimensions of cover panels</b>	2 pcs, width = width of the lift -10 mm, height 438 mm, thickness 12-20 mm
<b>Width of top board</b>	Width = width of the lift
<b>Depth of top board</b>	565-630 mm (15 mm shallower than worktops on fixed cabinets)
<b>Gap to the side to wall/adjoining cabinet</b>	5 mm
<b>Gap to wall (for tiling)</b>	15 mm
<b>Tiling</b>	From 700 mm above the floor (alternatively all the way down to the floor)
<b>Delivery modules</b>	Ready-mounted worktop incl. wall-mounted brackets
<b>Fittings enclosed</b>	Brackets for fronts and top board
<b>Material specifications</b>	Aluminium frame
<b>Guarantee</b>	2 years
	<b>CE</b>

### Measurement data

(mm)

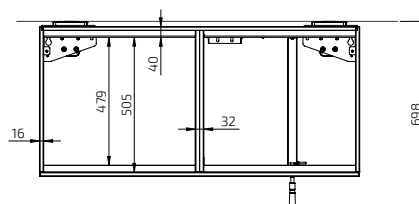
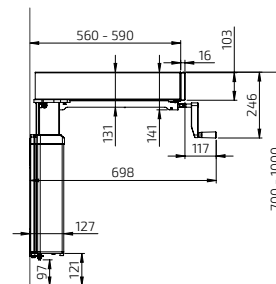
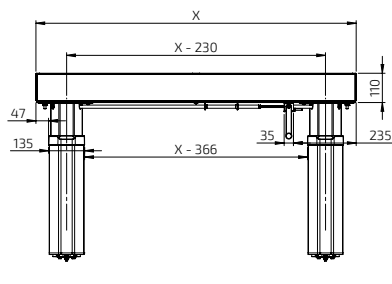

**MANULIFT 6350HA**

Wall-mounted worktop unit 59.0-100.0 cm width



Width (cm)	Art. no.
59.0	6350HA-059
60.0	6350HA-060
69.0	6350HA-069
70.0	6350HA-070
79.0	6350HA-079
80.0	6350HA-080
89.0	6350HA-089
90.0	6350HA-090
99.0	6350HA-099
100.0	6350HA-100

**MANULIFT 6350HA**

Wall-mounted worktop unit 109.0 - 180.0 cm width



109.0	6350HA-109
110.0	6350HA-110
119.0	6350HA-119
120.0	6350HA-120
129.0	6350HA-129
130.0	6350HA-130
139.0	6350HA-139
140.0	6350HA-140
149.0	6350HA-149
150.0	6350HA-150
159.0	6350HA-159
160.0	6350HA-160
169.0	6350HA-169
170.0	6350HA-170
179.0	6350HA-179
180.0	6350HA-180

**MANULIFT 6350HA**

Wall-mounted worktop unit 189.0 - 240.0 cm width



189.0	6350HA-189
190.0	6350HA-190
199.0	6350HA-199
200.0	6350HA-200
209.0	6350HA-209
210.0	6350HA-210
219.0	6350HA-219
220.0	6350HA-220
229.0	6350HA-229
230.0	6350HA-230
239.0	6350HA-239
240.0	6350HA-240



	<p><b>Power Socket, Black</b>                      Diameter 68 mm, Drilling: 56 mm                      Installation depth 45 mm                      Cable length 2 m                      Earthed (EU 2-pin) 61333                      Earthed (UK 3-pin) 61333.UK</p>		<p><b>Cover panels</b>                      Used to cover installations under the worktop.                      12 mm white melamine, 2 pcs height 438 mm                      6260-240</p>
	<p><b>Socket, ALU-design</b>                      Earthed socket 230 V with flap cover.                      Dimensions: 82 x 82 x 17 mm                      Earthed (EU 2-pin) 61330</p>		<p><b>Fittings set for cover panels</b>                      Used to mount cover panels that conceal installations under the worktop.                      Colour: Alu-grey RAL 9006                      6260-005</p>
	<p><b>Power switch, ALU-design</b>                      For lighting, for example. The button has a sign for desired marking.                      Dimensions: 82 x 82 x 17 mm                      61331</p>		<p><b>Hose cover</b>                      The hose cover is mounted anywhere under the worktop, (next to motors, if applicable) to provide a neat coverage of hoses when the cover panels are not in use. Fittings are included.</p>
	<p><b>Multi-compartment frame, ALU-design</b>                      Collects power socket and power switch in a multi-compartment frame.                      Two-compartment frame: 153 x 82 x 9 mm 61352                      Three-compartment frame: 225 x 82 x 9 mm 61353</p>		<p>Width: 410 mm, Depth: 200 mm                      White plastic 61504-01                      Grey plastic 61504-06</p>
	<p><b>Front, white-lacquered aluminium</b>                      Replace xxx with cm when ordering. Example, 385H-040-01 for 40.0 cm                      Lacquered aluminium, white RAL 9003                      Height: 103 mm                      Optional length, 20.0-340.0 cm 385H-xxx-01</p>		<p><b>Rear edge trim in aluminium for top board</b>                      Mounted behind the top board. Brushed aluminium                      Height above top board: 20 mm                      Thickness behind top board: 3 mm (per metre) 6943-06</p>
	<p><b>Front, anodised aluminium</b>                      Replace xxx with cm when ordering. Example, 385H-040-06 for 40.0 cm                      Anodised aluminium                      Height: 103 mm                      Optional length, 20.0-340.0 cm 385H-xxx-06</p>		
	<p><b>Integrated drawer with full extension and soft-close or push-to-open function</b>                      Depth: 470 mm, height: 85 mm                      Colour: Anthracite (RAL 9004)                      30.0 cm 465H-030                      40.0 cm 465H-040                      50.0 cm 465H-050                      60.0 cm 465H-060                      80.0 cm 465H-080                      30.0 cm - Push-to-open function 466H-030                      40.0 cm - Push-to-open function 466H-040                      50.0 cm - Push-to-open function 466H-050                      60.0 cm - Push-to-open function 466H-060                      80.0 cm - Push-to-open function 466H-080</p>		
	<p><b>Cutlery compartment</b>                      Fits 30.0 cm wide drawer 463-030                      Fits 40.0 cm wide drawer 463-040                      Fits 50.0 cm wide drawer 463-050                      Fits 60.0 cm wide drawer 463-060                      Fits 80.0 cm wide drawer 463-080</p>		
	<p><b>Hob cover under worktop lift</b>                      Provides a smooth underside. Used under the hob.                      White-lacquered metal RAL 9003                      60.0 cm 6266-060                      70.0 cm 6266-070                      80.0 cm 6266-080                      90.0 cm 6266-090                      100.0 cm 6266-100</p>		

# MANULIFT 6380

Wall-mounted manually height-adjustable worktop unit

MANULIFT 6380 is a manually adjustable worktop unit.

Under the worktop, space is left for the knees and legs. Installations under the worktop, (brackets, water, sewers), can be concealed by telescopic cover panels which gives the kitchen a neat look.

The height is adjustable by 300 mm at 25 mm intervals. A built-in gas spring facilitates the adjustment. The lift is prepared in the factory to facilitate easy installation.

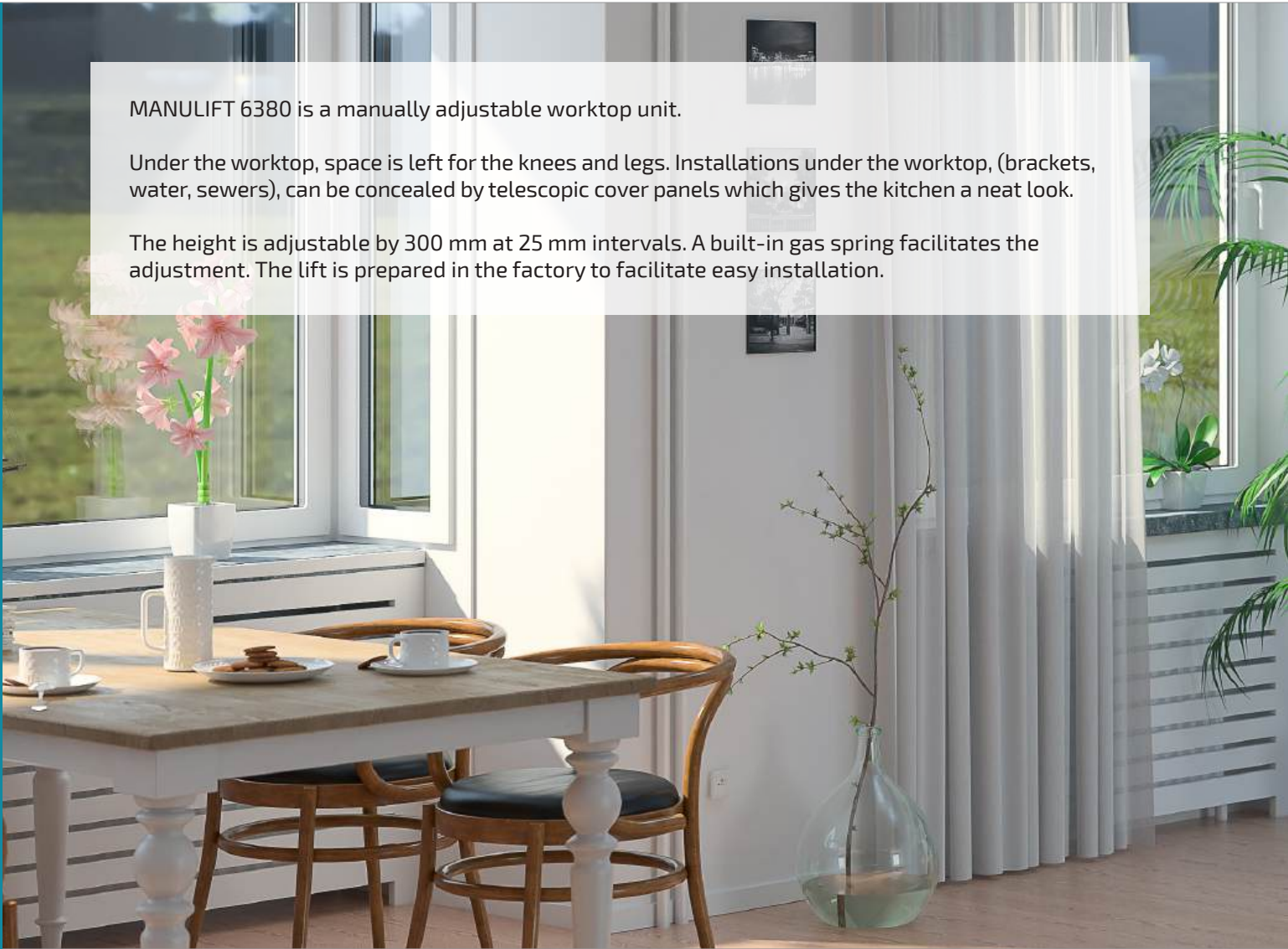

Sink, hob and drawer can be integrated into the worktop.



A built-in gas spring facilitates height adjustment:  
Pull out the locking pin, adjust the height, (the gas spring provides lifting help).  
Lock the position with the locking pin.





### Functions and advantages

- Manually height-adjustable worktop unit
- Height-adjustable 70-100 cm above the floor (excl. top board)
- A built-in gas spring facilitates height adjustment
- The frame depth is adjustable 56-59 cm to fit adjoining cabinet
- The upper part of the lifting system is delivered ready-mounted. The sides are pre-assembled and adjustable sideways to suit the sink, hob and drawers
- The lifting system is adjustable at an angle to compensate for an inclined wall
- 10 cm free space under the wall brackets for electrical installations and piping

### Standard equipment

- Factory-mounted aluminium system with movable and tiltable brackets
- Wall brackets with built-in gas spring

### Recommended additional options

- |                           |                  |
|---------------------------|------------------|
| - Front                   | - Rear edge trim |
| - Hose cover/cover panels | - Top board      |
| - Sink (Not 6380L)        | - Hob            |
| - Drawer (not 6380L)      |                  |

### Useful information

- Fittings for top board and fronts enclosed
- The top board's depth must be 15 mm shallower than adjoining top boards (to provide a gap for tiles and movement)
- Width of the top board = width of the lift
- Sink bowls with a maximum height of 120 mm can be integrated (Not 6380L)
- Width of front = width of lift -4 mm  
Height of front: 6380H = 103 mm, 6380L = 40 mm  
Fittings enclosed
- Cover panels can hide installations under the worktop  
2 pcs width = width of lift -10 mm, height 438 mm, thickness 12-20 mm

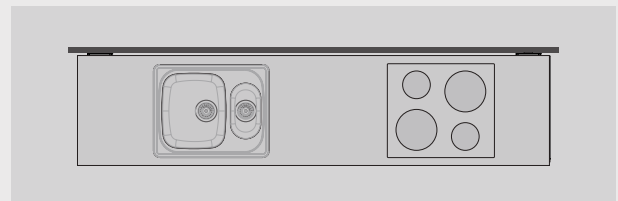

### Specify the location of drawers, sink and hob

The worktop is prepared in the factory. Drawers are mounted and sides assembled to facilitate the final mounting on the spot.



6380H



6380L



### Specifications

<b>Mounting</b>	Wall
<b>Height adjustment</b>	Manually adjustable by 300 mm in intervals of 25 mm (700-1000 mm excl. top board) A built-in gas spring facilitates height adjustment: <i>Pull out the locking pin, adjust the height with the help of the gas spring. Lock the position with the locking pin.</i>
<b>Plumbing connections</b>	Connection is made with flexible hoses
<b>Maximum load</b>	100 kg
<b>Frame depth</b>	560-590 mm from wall
<b>Front height</b>	40 or 103 mm
<b>Dimensions of cover panels</b>	2 pcs, width = width of the lift -10 mm, height 438 mm, thickness 12-20 mm
<b>Width of top board</b>	Width = width of the lift
<b>Depth of top board</b>	565-630 mm (15 mm shallower than worktops on fixed cabinets)
<b>Gap to the side to wall/ adjoining cabinet</b>	5 mm
<b>Gap to wall (for tiling)</b>	15 mm
<b>Tiling</b>	From 700 mm above the floor (alternatively all the way down to the floor)
<b>Delivery modules</b>	Ready-mounted worktop incl. wall-mounted brackets
<b>Fittings enclosed</b>	Brackets for fronts and top board
<b>Material specifications</b>	Aluminium frame
<b>Guarantee</b>	2 years
	<b>CE</b>

### Measurement data

(mm)

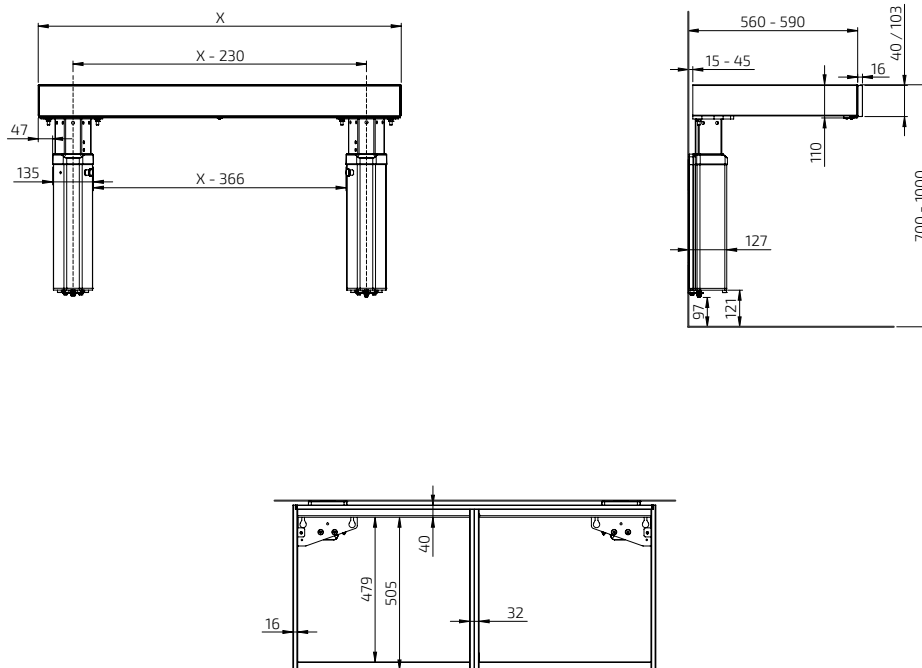

**MANULIFT 6380HA**

Wall-mounted worktop unit 59.0-100.0 cm width



Width (cm)	Art. no.
59.0	6380HA-059
60.0	6380HA-060
69.0	6380HA-069
70.0	6380HA-070
79.0	6380HA-079
80.0	6380HA-080
89.0	6380HA-089
90.0	6380HA-090
99.0	6380HA-099
100.0	6380HA-100

**MANULIFT 6380HA**

Wall-mounted worktop unit 109.0 - 180.0 cm width



109.0	6380HA-109
110.0	6380HA-110
119.0	6380HA-119
120.0	6380HA-120
129.0	6380HA-129
130.0	6380HA-130
139.0	6380HA-139
140.0	6380HA-140
149.0	6380HA-149
150.0	6380HA-150
159.0	6380HA-159
160.0	6380HA-160
169.0	6380HA-169
170.0	6380HA-170
179.0	6380HA-179
180.0	6380HA-180

**MANULIFT 6380HA**

Wall-mounted worktop unit 189.0 - 240.0 cm width



189.0	6380HA-189
190.0	6380HA-190
199.0	6380HA-199
200.0	6380HA-200
209.0	6380HA-209
210.0	6380HA-210
219.0	6380HA-219
220.0	6380HA-220
229.0	6380HA-229
230.0	6380HA-230
239.0	6380HA-239
240.0	6380HA-240

	<p><b>Power Socket, Black</b>                      Diameter 68 mm, Drilling: 56 mm                      Installation depth 45 mm                      Cable length 2 m                      Earthed (EU 2-pin) 61333                      Earthed (UK 3-pin) 61333.UK</p>		<p><b>Cover panels</b>                      Used to cover installations under the worktop.                      12 mm white melamine, 2 pcs height 438 mm                      6260-240</p>
	<p><b>Socket, ALU-design</b>                      Earthed socket 230 V with flap cover.                      Dimensions: 82 x 82 x 17 mm                      Earthed (EU 2-pin) 61330</p>		<p><b>Fittings set for cover panels</b>                      Used to mount cover panels that conceal installations under the worktop.                      Colour: Alu-grey RAL 9006                      6260-005</p>
	<p><b>Power switch, ALU-design</b>                      For lighting, for example. The button has a sign for desired marking.                      Dimensions: 82 x 82 x 17 mm                      61331</p>		<p><b>Hose cover</b>                      The hose cover is mounted anywhere under the worktop, (next to motors, if applicable) to provide a neat coverage of hoses when the cover panels are not in use. Fittings are included.</p>
	<p><b>Multi-compartment frame, ALU-design</b>                      Collects power socket and power switch in a multi-compartment frame.                      Two-compartment frame: 153 x 82 x 9 mm 61352                      Three-compartment frame: 225 x 82 x 9 mm 61353</p>		<p>Width: 410 mm, Depth: 200 mm                      White plastic 61504-01                      Grey plastic 61504-06</p>
	<p><b>Front, white-lacquered aluminium</b>                      Replace xxx with cm when ordering. Example, 385H-040-01 for 40.0 cm                      Lacquered aluminium, white RAL 9003                      Height: 103 mm                      Optional length, 20.0-340.0 cm 385H-xxx-01</p>		<p><b>Rear edge trim in aluminium for top board</b>                      Mounted behind the top board. Brushed aluminium                      Height above top board: 20 mm                      Thickness behind top board: 3 mm (per metre) 6943-06</p>
	<p><b>Front, anodised aluminium</b>                      Replace xxx with cm when ordering. Example, 385H-040-06 for 40.0 cm                      Anodised aluminium                      Height: 103 mm                      Optional length, 20.0-340.0 cm 385H-xxx-06</p>		
	<p><b>Integrated drawer with full extension and soft-close or push-to-open function</b>                      Depth: 470 mm, height: 85 mm                      Colour: Anthracite (RAL 9004)                      30.0 cm 465H-030                      40.0 cm 465H-040                      50.0 cm 465H-050                      60.0 cm 465H-060                      80.0 cm 465H-080                      30.0 cm - Push-to-open function 466H-030                      40.0 cm - Push-to-open function 466H-040                      50.0 cm - Push-to-open function 466H-050                      60.0 cm - Push-to-open function 466H-060                      80.0 cm - Push-to-open function 466H-080</p>		
	<p><b>Cutlery compartment</b>                      Fits 30.0 cm wide drawer 463-030                      Fits 40.0 cm wide drawer 463-040                      Fits 50.0 cm wide drawer 463-050                      Fits 60.0 cm wide drawer 463-060                      Fits 80.0 cm wide drawer 463-080</p>		
	<p><b>Hob cover under worktop lift</b>                      Provides a smooth underside. Used under the hob.                      White-lacquered metal RAL 9003                      60.0 cm 6266-060                      70.0 cm 6266-070                      80.0 cm 6266-080                      90.0 cm 6266-090                      100.0 cm 6266-100</p>		

**MANULIFT 6380LA**

Wall-mounted worktop unit 59.0-100.0 cm width



Width (cm)	Art. no.
59.0	6380LA-059
60.0	6380LA-060
69.0	6380LA-069
70.0	6380LA-070
79.0	6380LA-079
80.0	6380LA-080
89.0	6380LA-089
90.0	6380LA-090
99.0	6380LA-099
100.0	6380LA-100

**MANULIFT 6380LA**

Wall-mounted worktop unit 109.0 - 180.0 cm width



109.0	6380LA-109
110.0	6380LA-110
119.0	6380LA-119
120.0	6380LA-120
129.0	6380LA-129
130.0	6380LA-130
139.0	6380LA-139
140.0	6380LA-140
149.0	6380LA-149
150.0	6380LA-150
159.0	6380LA-159
160.0	6380LA-160
169.0	6380LA-169
170.0	6380LA-170
179.0	6380LA-179
180.0	6380LA-180







**MANULIFT 6380LA**

Wall-mounted worktop unit 189.0 - 240.0 cm width



189.0	6380LA-189
190.0	6380LA-190
199.0	6380LA-199
200.0	6380LA-200
209.0	6380LA-209
210.0	6380LA-210
219.0	6380LA-219
220.0	6380LA-220
229.0	6380LA-229
230.0	6380LA-230
239.0	6380LA-239
240.0	6380LA-240



	<p><b>Front, white-lacquered aluminium</b></p> <p>Replace xxx with cm when ordering. For example, 385L-040-01 for 40.0 cm</p> <p>Lacquered aluminium, white RAL 9003 Height: 40 mm Optional length, 20.0-340.0 cm</p>	<p>385L-xxx-01</p>
	<p><b>Front, anodised aluminium</b></p> <p>Replace xxx with cm when ordering. For example, 385L-040-06 for 40.0 cm</p> <p>Anodised aluminium Height: 40 mm Optional length, 20.0-340.0 cm</p>	<p>385L-XXX-06</p>
	<p><b>Hob cover under worktop lift</b></p> <p>Provides a smooth underside. Used under the hob. White-lacquered metal RAL 9003</p> <p>60.0 cm</p> <p>70.0 cm</p> <p>80.0 cm</p> <p>90.0 cm</p> <p>100.0 cm</p>	<p>6266-060</p> <p>6266-070</p> <p>6266-080</p> <p>6266-090</p> <p>6266-100</p>
	<p><b>Cover panels</b></p> <p>Used to cover installations under the worktop.</p> <p>12 mm white melamine 2 pcs height 438 mm</p>	<p>6260-240</p>
	<p><b>Fittings set for cover panels</b></p> <p>Used to mount cover panels that conceal installations under the worktop.</p> <p>Colour: Alu-grey RAL 9006</p>	<p>6260-005</p>
	<p><b>Rear edge trim in aluminium for top board</b></p> <p>Mounted behind the top board. Brushed aluminium Height above top board: 20 mm Thickness behind top board: 3 mm (per metre)</p>	<p>6943-06</p>

# CENTERLIFT 960

Motorised kitchen island with space for knees

Both tall and short people work in the kitchen and everyone needs different working heights. Moreover, different kitchen chores require different working heights.

CENTERLIFT creates a kitchen in which everyone can work comfortably while also providing a natural hub in the kitchen where people can gather, on an ordinary weekday or on festive occasions.

The lifting system can be integrated with kitchens from any kitchen manufacturer.

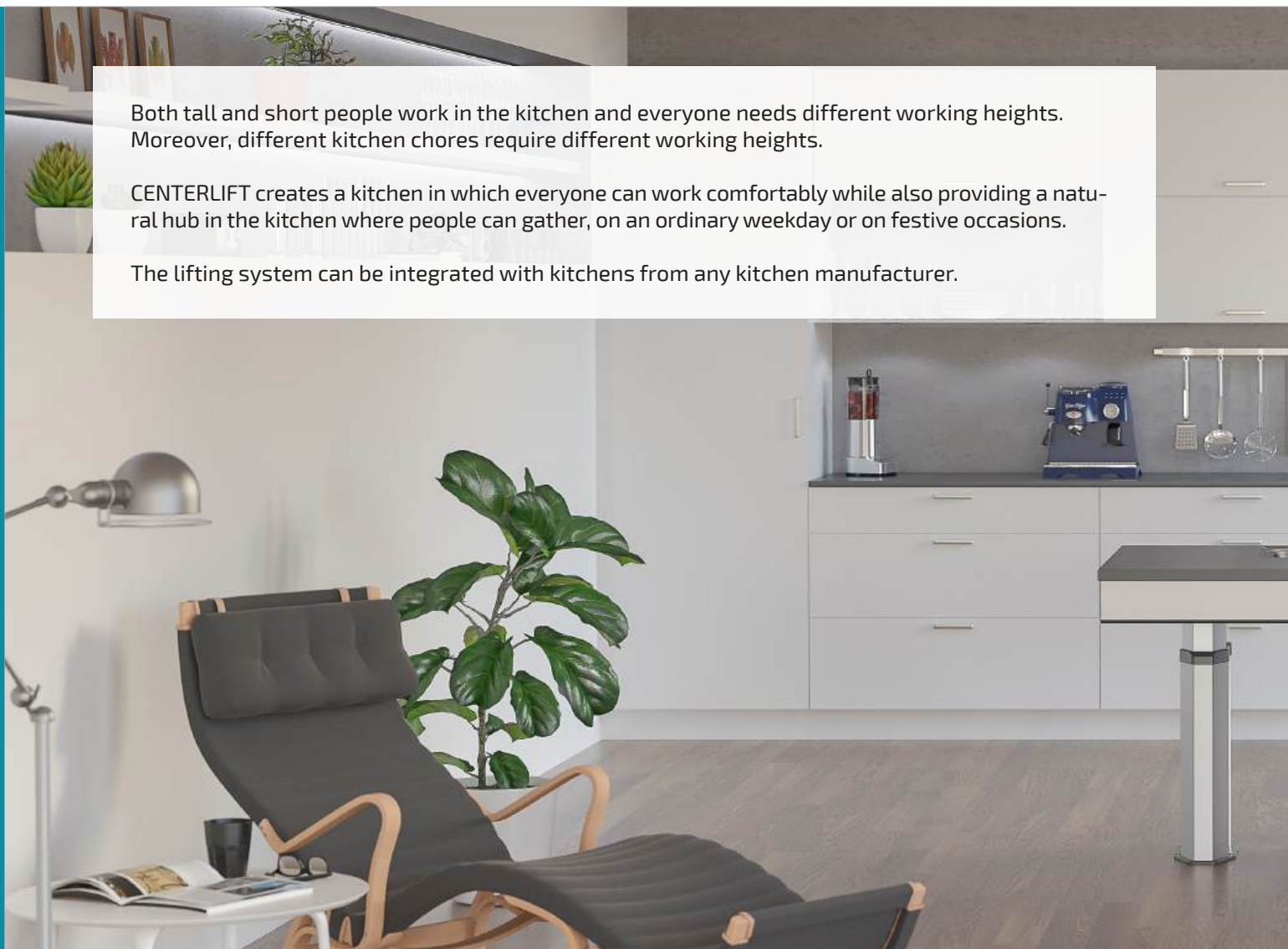

The kitchen island can be designed to suit individual needs. Here, an inset sink with a shallow sink bowl has been integrated with the kitchen island.



The hob can be integrated with the kitchen island and thus becomes accessible from both a standing and sitting position.





### Functions and advantages

- Motorised kitchen island lift
- Height-adjustable 70-110 cm above floor (excl. top board)
- 200 kg lifting power
- The upper part of the lifting system is delivered ready-mounted. The sides are pre-assembled and adjustable side-ways to suit the sink and hob
- Integrated safety switch

### Standard equipment

- Factory-mounted aluminium system with movable brackets
- Floor-mounted motors
- Safety switch

### Recommended additional options

- Control button
- Front
- Sink
- Top board
- Hob

### Useful information

- Fittings for top board enclosed
- Sink bowls with a maximum height of 120 mm can be integrated
- Electronics and motor system "Plug and Play"
- The position of the motors is adjustable to the side (then screwed into the floor)



#### Specify the location of sink and hob

The worktop is prepared in the factory. Dividers have been positioned to facilitate the final mounting on the spot.





### Specifications

<b>Mounting</b>	Floor
<b>Height adjustment</b>	Motorised, steplessly adjustable 400 mm (700-1100 mm excl. top board)
<b>Speed</b>	30 mm / sec.
<b>Manoeuvring</b>	Recessed mounted button or radio control
<b>Safety</b>	The safety strip is placed under the frame. If anything touches the safety strip, the lifting unit stops
<b>Electricity connection</b>	Plug for 230 V, 2 x 5A
<b>Plumbing connections</b>	Connection is made with flexible hoses
<b>Lifting power</b>	200 kg
<b>IP Class</b>	IP 20
<b>Frame depth incl. front</b>	580 / 780 / 980 / 1180 mm
<b>Frame depth for own front</b>	548 / 748 / 948 / 1148 mm
<b>Width of top board</b>	1200 / 1400 / 1600 / 1800 / 2000 / 2200 / 2400 / 2600 / 2800 mm
<b>Depth of top board</b>	600 / 800 / 1000 / 1200 mm
<b>Front height</b>	103 mm
<b>Delivery modules</b>	Ready-mounted worktop incl. safety switch, motors
<b>Fittings enclosed</b>	Brackets for fronts and top board
<b>Material specifications</b>	Aluminium frame
<b>Guarantee</b>	2 years



### Measurement data

(mm)

Width (X) Frame incl. front	Width (X) Frame for own front	Width Top board
1180 mm	1148 mm	1200 mm
1380 mm	1348 mm	1400 mm
1580 mm	1548 mm	1600 mm
1780 mm	1748 mm	1800 mm
1980 mm	1948 mm	2000 mm
2180 mm	2148 mm	2200 mm
2380 mm	2348 mm	2400 mm
2580 mm	2548 mm	2600 mm
2780 mm	2748 mm	2800 mm

Depth (Y) Frame incl. front	Depth (Y) Frame for own front	Depth Top board
580 mm	548 mm	600 mm
780 mm	748 mm	800 mm
980 mm	948 mm	1000 mm
1180 mm	1148 mm	1200 mm

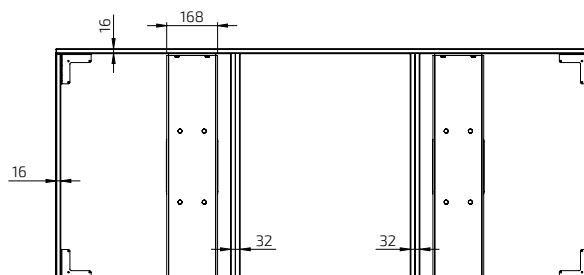
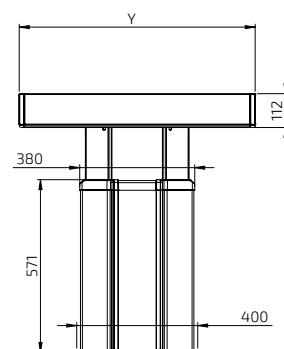
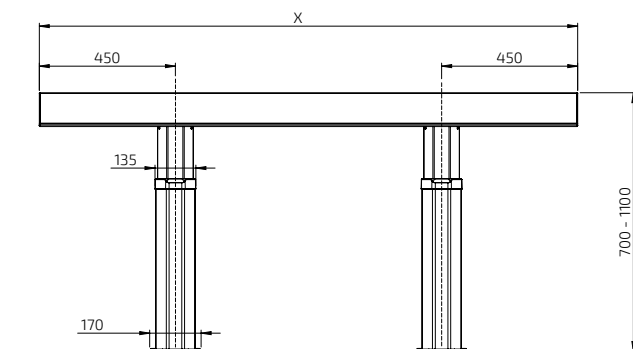

**CENTERLIFT 960HA**

Depth 58.0 cm, white or anodised aluminium front  
-Adjustability: 70.0-110.0 cm (40.0 cm)



For worktop (cm)	Width (cm)	Depth (cm)	Art. no White Alu. front	Art. no Anodised Alu. front
120.0 x 60.0 cm	118.0	58.0	960HA-120-01	960HA-120-06
140.0 x 60.0 cm	138.0	58.0	960HA-140-01	960HA-140-06
160.0 x 60.0 cm	158.0	58.0	960HA-160-01	960HA-160-06
180.0 x 60.0 cm	178.0	58.0	960HA-180-01	960HA-180-06
200.0 x 60.0 cm	198.0	58.0	960HA-200-01	960HA-200-06
220.0 x 60.0 cm	218.0	58.0	960HA-220-01	960HA-220-06
240.0 x 60.0 cm	238.0	58.0	960HA-240-01	960HA-240-06
260.0 x 60.0 cm	258.0	58.0	960HA-260-01	960HA-260-06
280.0 x 60.0 cm	278.0	58.0	960HA-280-01	960HA-280-06

**CENTERLIFT 960HC**

-Depth 78.0 cm, white or anodised aluminium front  
-Adjustability: 70.0-110.0 cm (40.0 cm)



For worktop (cm)	Width (cm)	Depth (cm)	Art. no White Alu. front	Art. no Anodised Alu. front
120.0 x 80.0 cm	118.0	78.0	960HC-120-01	960HC-120-06
140.0 x 80.0 cm	138.0	78.0	960HC-140-01	960HC-140-06
160.0 x 80.0 cm	158.0	78.0	960HC-160-01	960HC-160-06
180.0 x 80.0 cm	178.0	78.0	960HC-180-01	960HC-180-06
200.0 x 80.0 cm	198.0	78.0	960HC-200-01	960HC-200-06
220.0 x 80.0 cm	218.0	78.0	960HC-220-01	960HC-200-06
240.0 x 80.0 cm	238.0	78.0	960HC-240-01	960HC-240-06
260.0 x 80.0 cm	258.0	78.0	960HC-260-01	960HC-260-06
280.0 x 80.0 cm	278.0	78.0	960HC-280-01	960HC-280-06

**CENTERLIFT 960HE**

-Depth 98.0 cm, white or anodised aluminium front  
-Adjustability: 70.0-110.0 cm (40.0 cm)



For worktop (cm)	Width (cm)	Depth (cm)	Art. no White Alu. front	Art. no Anodised Alu. front
120.0 x 100.0 cm	118.0	98.0	960HE-120-01	960HE-120-06
140.0 x 100.0 cm	138.0	98.0	960HE-140-01	960HE-140-06
160.0 x 100.0 cm	158.0	98.0	960HE-160-01	960HE-160-06
180.0 x 100.0 cm	178.0	98.0	960HE-180-01	960HE-180-06
200.0 x 100.0 cm	198.0	98.0	960HE-200-01	960HE-200-06
220.0 x 100.0 cm	218.0	98.0	960HE-220-01	960HE-220-06
240.0 x 100.0 cm	238.0	98.0	960HE-240-01	960HE-240-06
260.0 x 100.0 cm	258.0	98.0	960HE-260-01	960HE-260-06
280.0 x 100.0 cm	278.0	98.0	960HE-280-01	960HE-280-06

**CENTERLIFT 960HF**

-Depth 118.0 cm, white or anodised aluminium front  
-Adjustability: 70.0-110.0 cm (40.0 cm)



For worktop (cm)	Width (cm)	Depth (cm)	Art. no White Alu. front	Art. no Anodised Alu. front
120.0 x 120.0 cm	118.0	118.0	960HF-120-01	960HF-120-06
140.0 x 120.0 cm	138.0	118.0	960HF-140-01	960HF-140-06
160.0 x 120.0 cm	158.0	118.0	960HF-160-01	960HF-160-06
180.0 x 120.0 cm	178.0	118.0	960HF-180-01	960HF-180-06
200.0 x 120.0 cm	198.0	118.0	960HF-200-01	960HF-200-06
220.0 x 120.0 cm	218.0	118.0	960HF-220-01	960HF-220-06
240.0 x 120.0 cm	238.0	118.0	960HF-240-01	960HF-240-06
260.0 x 120.0 cm	258.0	118.0	960HF-260-01	960HF-260-06
280.0 x 120.0 cm	278.0	118.0	960HF-280-01	960HF-280-06

**CENTERLIFT 960HA - For own front**  
 - Depth 54.8 cm  
 - Adjustability: 70.0-110.0 cm (40.0 cm)



For worktop (cm)	Width (cm)	Depth (cm)	Art. no.
120.0 x 60.0 cm	114.8	54.8	960HA-120-00
140.0 x 60.0 cm	134.8	54.8	960HA-140-00
160.0 x 60.0 cm	154.8	54.8	960HA-160-00
180.0 x 60.0 cm	174.8	54.8	960HA-180-00
200.0 x 60.0 cm	194.8	54.8	960HA-200-00
220.0 x 60.0 cm	214.8	54.8	960HA-220-00
240.0 x 60.0 cm	234.8	54.8	960HA-240-00
260.0 x 60.0 cm	254.8	54.8	960HA-260-00
280.0 x 60.0 cm	274.8	54.8	960HA-280-00

**CENTERLIFT 960HC - For own front**  
 - Depth 74.8 cm  
 - Adjustability: 70.0-110.0 cm (40.0 cm)



For worktop (cm)	Width (cm)	Depth (cm)	Art. no.
120.0 x 80.0 cm	114.8	74.8	960HC-120-00
140.0 x 80.0 cm	134.8	74.8	960HC-140-00
160.0 x 80.0 cm	154.8	74.8	960HC-160-00
180.0 x 80.0 cm	174.8	74.8	960HC-180-00
200.0 x 80.0 cm	194.8	74.8	960HC-200-00
220.0 x 80.0 cm	214.8	74.8	960HC-220-00
240.0 x 80.0 cm	234.8	74.8	960HC-240-00
260.0 x 80.0 cm	254.8	74.8	960HC-260-00
280.0 x 80.0 cm	274.8	74.8	960HC-280-00

**CENTERLIFT 960HE - For own front**  
 - Depth 94.8 cm  
 - Adjustability: 70.0-110.0 cm (40.0 cm)



For worktop (cm)	Width (cm)	Depth (cm)	Art. no.
120.0 x 100.0 cm	114.8	94.8	960HE-120-00
140.0 x 100.0 cm	134.8	94.8	960HE-140-00
160.0 x 100.0 cm	154.8	94.8	960HE-160-00
180.0 x 100.0 cm	174.8	94.8	960HE-180-00
200.0 x 100.0 cm	194.8	94.8	960HE-200-00
220.0 x 100.0 cm	214.8	94.8	960HE-220-00
240.0 x 100.0 cm	234.8	94.8	960HE-240-00
260.0 x 100.0 cm	254.8	94.8	960HE-260-00
280.0 x 100.0 cm	274.8	94.8	960HE-280-00

**CENTERLIFT 960HF - For own front**  
 - Depth 114.8 cm  
 - Adjustability: 70.0-110.0 cm (40.0 cm)



For worktop (cm)	Width (cm)	Depth (cm)	Art. no.
120.0 x 120.0 cm	114.8	114.8	960HF-120-00
140.0 x 120.0 cm	134.8	114.8	960HF-140-00
160.0 x 120.0 cm	154.8	114.8	960HF-160-00
180.0 x 120.0 cm	174.8	114.8	960HF-180-00
200.0 x 120.0 cm	194.8	114.8	960HF-200-00
220.0 x 120.0 cm	214.8	114.8	960HF-220-00
240.0 x 120.0 cm	234.8	114.8	960HF-240-00
260.0 x 120.0 cm	254.8	114.8	960HF-260-00
280.0 x 120.0 cm	274.8	114.8	960HF-280-00



**Control button, Mini**  
 Wired, for recessed mounting  
 Diameter: 20 mm

61318



**Control button in ALU-design**  
 Wired, for recessed mounting  
 Dimensions: 82 x 82 x 17 mm

61320



**Radio control - Hand control**  
 Dimensions: 38 x 110 x 10 mm

61385



**Power Socket, Black**  
 Diameter 68 mm, Drilling: 56 mm  
 Installation depth 45 mm  
 Cable length 2 m

Earthed (EU 2-pin)

61333

Earthed (UK 3-pin)

61333.UK



**Socket, ALU-design**  
 Earthed socket 230 V with flap cover.  
 Dimensions: 82 x 82 x 17 mm

Earthed (EU 2-pin)

61330



**Power switch, ALU-design**  
 For lighting, for example. The button has a sign for desired marking.  
 Dimensions: 82 x 82 x 17 mm

61331



**Multi-compartment frame, ALU-design**  
 Collects power socket, power switch or control buttons in a multi-compartment frame.

Two-compartment frame:  
 153 x 82 x 9 mm

61352

Three-compartment frame:  
 225 x 82 x 9 mm

61353



**Safety lock**  
 Prevents unauthorised use.  
 Dimensions: 23 x 9 mm

61360



**Hose cover**  
 Mounted under the worktop to provide a neat coverage of hoses.

Anodised aluminium  
 Fittings are included.

Width: 300 mm, Depth: 200 mm

61508-06



# CENTERLIFT 6490

Motorised kitchen island with hanging cabinets and space for knees

CENTERLIFT 6490 is a motorised kitchen island.

With cabinets on one side and open space on the other side, a height-adjustable work area is created with space for knees on one side and generous storage space on the other.

CENTERLIFT creates a kitchen in which everyone can work comfortably while also providing a natural place for people to gather in the kitchen on all occasions.

The lifting system can be integrated with kitchens from any kitchen manufacturer.



One side is open to provide space for knees for work done sitting down.





Inset sink with shallow sink bowl and hob can be integrated with the kitchen island.



Any height adjustment moves the cabinets as well, providing an ergonomic kitchen island with good storage space.



### Functions and advantages

- Motorised kitchen island lift for cabinets and the part with space for knees
- Height-adjustable 70-110 cm above floor (excl. top board)
- 400 kg lifting power
- Safety switch under storage cabinet and the part with space for knees

### Standard equipment

- Factory-mounted aluminium system
- Floor-mounted motors
- Control button
- Safety switch at the part with space for knees

### Recommended additional options

- Hanging cabinets
- Cover package
- Fronts
- Safety plates (under hanging cabinets)
- Top board
- Sink
- Hob

### Useful information

- Fittings for worktop and fronts are included
- Worktop width = lift width + thickness of side cover + desired protrusion
- Worktop depth = lift depth (1106 mm) + thickness of front cover + desired protrusion
- Electronics and motor system "Plug and Play"
- Cover panel can hide installations under the worktop on the side with space for knees  
1 pc, width = width of lift, height 510 mm, thickness 12-20 mm

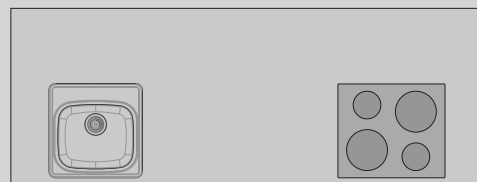

### Specify the location of drawers, sink and hob

The worktop is prepared in the factory to facilitate final assembly on site.



### Specifications

<b>Mounting</b>	Floor
<b>Height adjustment</b>	Motorised, steplessly adjustable 400 mm (700-1100 mm excl. top board)
<b>Speed</b>	20 mm / sec.
<b>Manoeuvring</b>	Recessed mounted buttons located in the motor units (left and right side)
<b>Safety</b>	Safety switches under the cabinet and under the front of spaces for knees. The function of the safety switch is to stop the movement if it comes in contact with any object.
<b>Electricity connection</b>	Plug for 230 V, max 5.0 A
<b>Plumbing connections</b>	Connection is made with flexible hoses
<b>Lifting power</b>	400 kg
<b>IP Class</b>	IP 20
<b>Frame depth</b>	1106 mm
<b>Front height of side with space for knees</b>	103 mm
<b>Dimensions of cover panel on the side with space for knees</b>	1 pc, width = width of lift, height 510 mm, thickness 12-20 mm
<b>Width of top board</b>	Width of lift + thickness of the side cover + Desired protrusion
<b>Depth of top board</b>	Depth of lift (1106 mm) + thickness of the front cover + Desired protrusion
<b>Delivery modules</b>	1 package with motor units. 1 package with length-dependent beams. 1 package with ready-mounted aluminium system for the part with space for knees
<b>Fittings enclosed</b>	Brackets for fronts and top board
<b>Material specifications</b>	Motor units in lacquered steel (S235JRG2). Aluminium beams Aluminium frame for the part with space for knees
<b>Guarantee</b>	2 years
	<b>CE</b>

### Measurement data

(mm)

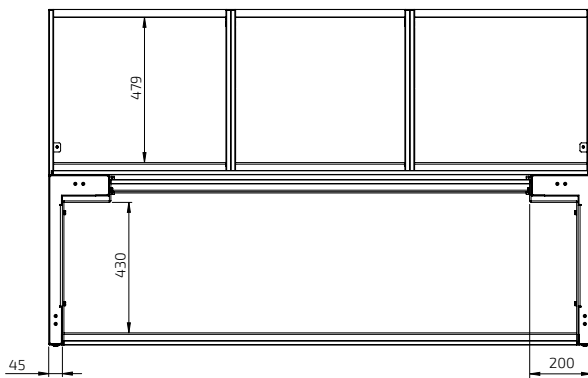
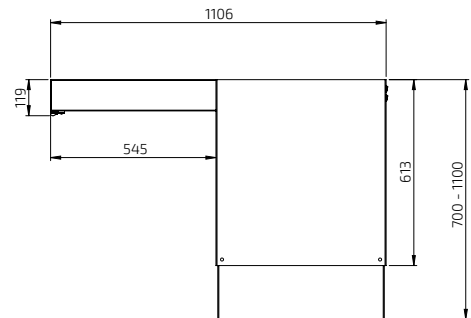
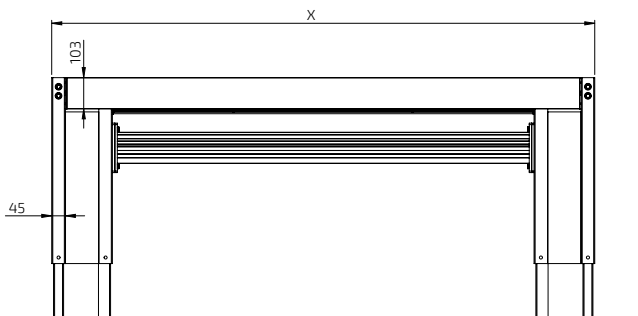





Side with space for knees for work done when seated.



Cabinet side with generous storage space.



The cabinets are equipped with two fully-extendable, soft-close drawers.



The side with space for knees can be equipped with drawers.



Safety system in the form of safety plates under cabinets and safety strips under the part with space for knees stops the machinery if any object comes into contact with the switches.



Supplement with a mini cabinet on wheels for waste sorting.



**CENTERLIFT 6490**

-White RAL 9003

-Incl. control button Mini in the motor units (left and right side)



Width (cm)	Art. no.	Width (cm)	Art. no.
79.0	6490HA-079-01	209.0	6490HA-209-01
89.0	6490HA-089-01	219.0	6490HA-219-01
99.0	6490HA-099-01	229.0	6490HA-229-01
109.0	6490HA-109-01	239.0	6490HA-239-01
119.0	6490HA-119-01	249.0	6490HA-249-01
129.0	6490HA-129-01	259.0	6490HA-259-01
139.0	6490HA-139-01	269.0	6490HA-269-01
149.0	6490HA-149-01	279.0	6490HA-279-01
159.0	6490HA-159-01	289.0	6490HA-289-01
169.0	6490HA-169-01	299.0	6490HA-299-01
179.0	6490HA-179-01	309.0	6490HA-309-01
189.0	6490HA-189-01	319.0	6490HA-319-01
199.0	6490HA-199-01	329.0	6490HA-329-01

**CENTERLIFT 6490**

- Anthracite RAL 9004

- Incl. control button Mini in the motor units (left and right side)



79.0	6490HA-079-07	209.0	6490HA-209-07
89.0	6490HA-089-07	219.0	6490HA-219-07
99.0	6490HA-099-07	229.0	6490HA-229-07
109.0	6490HA-109-07	239.0	6490HA-239-07
119.0	6490HA-119-07	249.0	6490HA-249-07
129.0	6490HA-129-07	259.0	6490HA-259-07
139.0	6490HA-139-07	269.0	6490HA-269-07
149.0	6490HA-149-07	279.0	6490HA-279-07
159.0	6490HA-159-07	289.0	6490HA-289-07
169.0	6490HA-169-07	299.0	6490HA-299-07
179.0	6490HA-179-07	309.0	6490HA-309-07
189.0	6490HA-189-07	319.0	6490HA-319-07
199.0	6490HA-199-07	329.0	6490HA-329-07

**Recommended accessories**

**Cabinet side**



Cover package



Front that conceals the lifting frame



Hanging cabinets



Safety plates (under cabinets)



**Side with space for knees**



Control button



Front









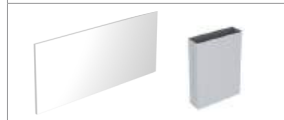

Drawer

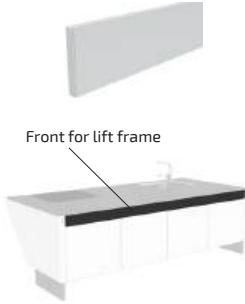

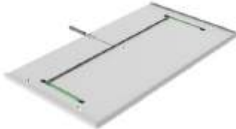
Cover panel and hose cover



 <p><b>Hanging cabinet with drawers</b> The cabinet has a large drawer and a smaller inner drawer for cutlery and utensils.</p> <p>Fully extendable with soft-close. Frame height 510 mm Frame depth: 470 mm</p> <p>Frame in white melamine. White-lacquered door (NCS 0500-N)</p>	<table border="1"> <tr><td>30.0 cm</td><td>760-030-01</td></tr> <tr><td>40.0 cm</td><td>760-040-01</td></tr> <tr><td>50.0 cm</td><td>760-050-01</td></tr> <tr><td>60.0 cm</td><td>760-060-01</td></tr> <tr><td>70.0 cm</td><td>760-070-01</td></tr> <tr><td>80.0 cm</td><td>760-080-01</td></tr> </table>	30.0 cm	760-030-01	40.0 cm	760-040-01	50.0 cm	760-050-01	60.0 cm	760-060-01	70.0 cm	760-070-01	80.0 cm	760-080-01		<p><b>Cutlery compartment for inner drawer</b></p> <table border="1"> <tr><td>Fits 30.0 cm wide inner drawer</td><td>460-030</td></tr> <tr><td>Fits 40.0 cm wide inner drawer</td><td>460-040</td></tr> <tr><td>Fits 50.0 cm wide inner drawer</td><td>460-050</td></tr> <tr><td>Fits 60.0 cm wide inner drawer</td><td>460-060</td></tr> <tr><td>Fits 70.0 cm wide inner drawer</td><td>460-070</td></tr> <tr><td>Fits 80.0 cm wide inner drawer</td><td>460-080</td></tr> </table> <p><b>Cover package</b> The package contains gable cover and gable front cover</p> <p>White-lacquered 16 mm MDF (NCS 0500-N)</p> <table border="1"> <tr><td></td><td>61515-01</td></tr> </table>	Fits 30.0 cm wide inner drawer	460-030	Fits 40.0 cm wide inner drawer	460-040	Fits 50.0 cm wide inner drawer	460-050	Fits 60.0 cm wide inner drawer	460-060	Fits 70.0 cm wide inner drawer	460-070	Fits 80.0 cm wide inner drawer	460-080		61515-01
30.0 cm	760-030-01																												
40.0 cm	760-040-01																												
50.0 cm	760-050-01																												
60.0 cm	760-060-01																												
70.0 cm	760-070-01																												
80.0 cm	760-080-01																												
Fits 30.0 cm wide inner drawer	460-030																												
Fits 40.0 cm wide inner drawer	460-040																												
Fits 50.0 cm wide inner drawer	460-050																												
Fits 60.0 cm wide inner drawer	460-060																												
Fits 70.0 cm wide inner drawer	460-070																												
Fits 80.0 cm wide inner drawer	460-080																												
	61515-01																												
 <p><b>Hanging cabinet with waste sorting bins, 40 cm</b> The cabinet is fitted with 2 waste bins. The upper part has an inner drawer for cutlery and utensils.</p> <p>Fully extendable with soft-close. Frame height 510 mm Frame depth: 470 mm</p> <p>Waste bins (litre): 1 pc 17 litre, 1 pc 11 litre</p> <p>Frame in white melamine. White-lacquered door (NCS 0500-N)</p>	<table border="1"> <tr><td></td><td>761-040-01</td></tr> </table>		761-040-01	 <p>Front for lift frame</p>	<p><b>Front that covers the lift frame</b> Front covering the lift frame above the drawer fronts.</p> <p>Total length: Width of lift -94 mm</p> <p>Replace xxx with cm when ordering. Example, 385H-040-01 for 40.0 cm</p> <p>Height: 103 mm</p> <table border="1"> <tr><td>White-painted front in MDF, NCS 0500-N</td><td>380H-xxx-01</td></tr> <tr><td>Lacquered aluminium, white RAL 9003</td><td>385H-xxx-01</td></tr> <tr><td>Lacquered ALU, anthracite RAL 9004</td><td>385H-xxx-07</td></tr> <tr><td>Anodised ALU</td><td>385H-xxx-06</td></tr> </table>	White-painted front in MDF, NCS 0500-N	380H-xxx-01	Lacquered aluminium, white RAL 9003	385H-xxx-01	Lacquered ALU, anthracite RAL 9004	385H-xxx-07	Anodised ALU	385H-xxx-06																
	761-040-01																												
White-painted front in MDF, NCS 0500-N	380H-xxx-01																												
Lacquered aluminium, white RAL 9003	385H-xxx-01																												
Lacquered ALU, anthracite RAL 9004	385H-xxx-07																												
Anodised ALU	385H-xxx-06																												
 <p><b>Hanging cabinet with waste sorting bins, 60 cm</b> The cabinet is fitted with 4 waste bins. The upper part has an inner drawer for cutlery and utensils.</p> <p>Fully extendable with soft-close. Frame height 510 mm Frame depth: 470 mm</p> <p>Waste bins (litre): 1 pc 17 litre, 1 pc 11 litre, 1 pc 8 litre, 1 pc 5 litre</p> <p>Frame in white melamine. White-lacquered door (NCS 0500-N)</p>	<table border="1"> <tr><td></td><td>761-060-01</td></tr> </table>		761-060-01		<p><b>Safety plates CENTERLIFT 6490</b> The function of the safety plate is to stop the movement of the cabinet if the plate comes into contact with any object. Mounted under the cabinets.</p> <p>Colour: White Thickness: 12 mm Depth: 466 mm</p> <table border="1"> <tr><td>30.0 cm width</td><td>6253-030-01</td></tr> <tr><td>40.0 cm width</td><td>6253-040-01</td></tr> <tr><td>50.0 cm width</td><td>6253-050-01</td></tr> <tr><td>60.0 cm width</td><td>6253-060-01</td></tr> <tr><td>70.0 cm width</td><td>6253-070-01</td></tr> <tr><td>80.0 cm width</td><td>6253-080-01</td></tr> </table>	30.0 cm width	6253-030-01	40.0 cm width	6253-040-01	50.0 cm width	6253-050-01	60.0 cm width	6253-060-01	70.0 cm width	6253-070-01	80.0 cm width	6253-080-01												
	761-060-01																												
30.0 cm width	6253-030-01																												
40.0 cm width	6253-040-01																												
50.0 cm width	6253-050-01																												
60.0 cm width	6253-060-01																												
70.0 cm width	6253-070-01																												
80.0 cm width	6253-080-01																												
 <p><b>Hanging cabinet under sink, 60 cm</b> The cabinet is fitted with 4 waste bins.</p> <p>Fully extendable with soft-close. Frame height 510 mm Frame depth: 470 mm</p> <p>Waste bins (litre): 1 pc 17 litre, 1 pc 11 litre, 1 pc 8 litre, 1 pc 5 litre</p> <p>Frame in white melamine. White-lacquered door (NCS 0500-N)</p>	<table border="1"> <tr><td></td><td>762-060-01</td></tr> </table>		762-060-01		<p><b>Safety package for safety plate of your own design</b> The safety package contains micro-switches and cables for mounting on your own board. Instructions with milling dimensions enclosed.</p> <p>The dimensions of the board must be: Thickness: 12-16 mm Width: 400 - 800 mm Depth: 466 mm</p> <table border="1"> <tr><td></td><td>6253-00</td></tr> </table>		6253-00																						
	762-060-01																												
	6253-00																												
 <p><b>Hanging cabinet under sink, 80 cm</b> The cabinet is fitted with 6 waste bins.</p> <p>Fully extendable with soft-close. Frame height 510 mm Frame depth: 470 mm Waste bins (litre): 1 pc 17 litre, 1 pc 11 litre, 2 pcs 8 litre, 2 pcs 5 litre</p> <p>Frame in white melamine. White-lacquered door (NCS 0500-N)</p>	<table border="1"> <tr><td></td><td>762-080-01</td></tr> </table>		762-080-01																										
	762-080-01																												
 <p><b>Fittings for hanging cabinet</b> One set per cabinet.</p>	<table border="1"> <tr><td></td><td>6250-001</td></tr> </table>		6250-001																										
	6250-001																												

	<p><b>Control button in ALU-design</b> Wired, for recessed mounting Dimensions: 82 x 82 x 17 mm</p> <p>61320</p>		<p><b>Cutlery compartment</b></p> <table border="1"> <tr><td>Fits 30.0 cm wide drawer</td><td>463-030</td></tr> <tr><td>Fits 40.0 cm wide drawer</td><td>463-040</td></tr> <tr><td>Fits 50.0 cm wide drawer</td><td>463-050</td></tr> <tr><td>Fits 60.0 cm wide drawer</td><td>463-060</td></tr> <tr><td>Fits 80.0 cm wide drawer</td><td>463-080</td></tr> </table>	Fits 30.0 cm wide drawer	463-030	Fits 40.0 cm wide drawer	463-040	Fits 50.0 cm wide drawer	463-050	Fits 60.0 cm wide drawer	463-060	Fits 80.0 cm wide drawer	463-080																		
Fits 30.0 cm wide drawer	463-030																														
Fits 40.0 cm wide drawer	463-040																														
Fits 50.0 cm wide drawer	463-050																														
Fits 60.0 cm wide drawer	463-060																														
Fits 80.0 cm wide drawer	463-080																														
	<p><b>Control button, Mini</b> Wired, for recessed mounting Diameter: 20 mm</p> <p>61318</p>		<p><b>Hob cover under worktop lift</b> Provides a smooth underside. Used under the hob. White-lacquered metal RAL 9003</p> <table border="1"> <tr><td>60.0 cm</td><td>6266-060</td></tr> <tr><td>70.0 cm</td><td>6266-070</td></tr> <tr><td>80.0 cm</td><td>6266-080</td></tr> <tr><td>90.0 cm</td><td>6266-090</td></tr> <tr><td>100.0 cm</td><td>6266-100</td></tr> </table>	60.0 cm	6266-060	70.0 cm	6266-070	80.0 cm	6266-080	90.0 cm	6266-090	100.0 cm	6266-100																		
60.0 cm	6266-060																														
70.0 cm	6266-070																														
80.0 cm	6266-080																														
90.0 cm	6266-090																														
100.0 cm	6266-100																														
	<p><b>Radio control - Hand control</b> Dimensions: 38 x 110 x 10 mm For one lift</p> <p>61385</p>		<p><b>Cover panel</b> Used to cover installations under the worktop.</p> <table border="1"> <tr><td>12 mm white melamine 1 pc height 510 mm</td><td></td></tr> <tr><td>2 pcs are required for lengths over 2490 mm</td><td>6263-240-01</td></tr> </table>	12 mm white melamine 1 pc height 510 mm		2 pcs are required for lengths over 2490 mm	6263-240-01																								
12 mm white melamine 1 pc height 510 mm																															
2 pcs are required for lengths over 2490 mm	6263-240-01																														
	<p><b>Power Socket, Black</b> Diameter 68 mm, Drilling: 56 mm Installation depth 45 mm Cable length 2 m</p> <table border="1"> <tr><td>Earthed (EU 2-pin)</td><td>61333</td></tr> <tr><td>Earthed (UK 3-pin)</td><td>61333.UK</td></tr> </table>	Earthed (EU 2-pin)	61333	Earthed (UK 3-pin)	61333.UK		<p><b>Fittings set for cover panels</b> Used to mount cover panels that conceal installations under the worktop.</p> <table border="1"> <tr><td>2 pcs are required for lengths over 2490 mm</td><td>6263-001</td></tr> </table>	2 pcs are required for lengths over 2490 mm	6263-001																						
Earthed (EU 2-pin)	61333																														
Earthed (UK 3-pin)	61333.UK																														
2 pcs are required for lengths over 2490 mm	6263-001																														
	<p><b>Socket, ALU-design</b> Earthed socket 230 V with flap cover. Dimensions: 82 x 82 x 17 mm Earthed (EU 2-pin)</p> <p>61330</p>		<p><b>Hose cover</b> Mounted under the worktop to provide a neat coverage of hoses.</p> <p>Anodised aluminium Fittings are included.</p> <table border="1"> <tr><td>Width: 300 mm, Depth: 85 mm</td><td>61509-06</td></tr> </table>	Width: 300 mm, Depth: 85 mm	61509-06																										
Width: 300 mm, Depth: 85 mm	61509-06																														
	<p><b>Power switch, ALU-design</b> For lighting, for example. The button has a sign for desired marking. Dimensions: 82 x 82 x 17 mm</p> <p>61331</p>		<p><b>Height-adjustment kit</b> Used to change stroke after installation. Contains programming box and memory adapter.</p> <p>61400</p>																												
	<p><b>Multi-compartment frame, ALU-design</b> Collects power socket, power switch or control buttons in a multi-compartment frame.</p> <table border="1"> <tr><td>Two-compartment frame: 153 x 82 x 9 mm</td><td>61352</td></tr> <tr><td>Three-compartment frame: 225 x 82 x 9 mm</td><td>61353</td></tr> </table>	Two-compartment frame: 153 x 82 x 9 mm	61352	Three-compartment frame: 225 x 82 x 9 mm	61353		<p><b>Mini cabinet on wheels with drawer and inner drawer, fully extendable with soft-close</b></p> <p>The cabinet is opened by pulling out the drawer.</p> <p>Width: 400 mm, Height: 574 mm Depth incl. grip handle: 495 mm</p> <p>Top board in white compact laminate with integrated grip handle.</p> <p>Frame in white melamine. White-lacquered door (NCS 0500-N)</p> <p>770-040-01</p>																								
Two-compartment frame: 153 x 82 x 9 mm	61352																														
Three-compartment frame: 225 x 82 x 9 mm	61353																														
	<p><b>Safety lock</b> Prevents unauthorised use. Dimensions: 23 x 9 mm</p> <p>61360</p>		<p><b>Mini cabinet on wheels with waste sorting and inner drawer, fully extendable with soft-close</b></p> <p>The cabinet is opened by pulling out the drawer. The bottom with the waste bins is included.</p> <p>Included bins: 1 pc 11 litre 1 pc 17 litre</p> <p>Width: 400 mm, Height: 574 mm Depth incl. grip handle: 495 mm</p> <p>Top board in white compact laminate with integrated grip handle.</p> <p>Frame in white melamine. White-lacquered door (NCS 0500-N)</p> <p>771-040-01</p>																												
	<p><b>Front for part with space for knees</b> Front that gives a neat look on the side with space for knees.</p> <p>Total length: Width of lift -94 mm Replace xxx with cm when ordering. Also used for drawers. Optional length, 20.0 - 340.0 cm Height: 103 mm</p> <table border="1"> <tr><td>Front in MDF, White NCS 0500-N</td><td>380H-xxx-01</td></tr> <tr><td>Lacquered Alu. white RAL 9003</td><td>385H-xxx-01</td></tr> <tr><td>Lacquered Alu. anthracite RAL 9004</td><td>385H-xxx-07</td></tr> <tr><td>Anodised aluminium</td><td>385H-xxx-06</td></tr> </table>	Front in MDF, White NCS 0500-N	380H-xxx-01	Lacquered Alu. white RAL 9003	385H-xxx-01	Lacquered Alu. anthracite RAL 9004	385H-xxx-07	Anodised aluminium	385H-xxx-06		<p><b>Integrated drawer with full extension and soft-close or push-to-open function</b> Depth: 470 mm, height: 85 mm Colour: Anthracite (RAL 9004)</p> <table border="1"> <tr><td>30.0 cm</td><td>465H-030</td></tr> <tr><td>40.0 cm</td><td>465H-040</td></tr> <tr><td>50.0 cm</td><td>465H-050</td></tr> <tr><td>60.0 cm</td><td>465H-060</td></tr> <tr><td>80.0 cm</td><td>465H-080</td></tr> <tr><td>30.0 cm - Push-to-open function</td><td>466H-030</td></tr> <tr><td>40.0 cm - Push-to-open function</td><td>466H-040</td></tr> <tr><td>50.0 cm - Push-to-open function</td><td>466H-050</td></tr> <tr><td>60.0 cm - Push-to-open function</td><td>466H-060</td></tr> <tr><td>80.0 cm - Push-to-open function</td><td>466H-080</td></tr> </table>	30.0 cm	465H-030	40.0 cm	465H-040	50.0 cm	465H-050	60.0 cm	465H-060	80.0 cm	465H-080	30.0 cm - Push-to-open function	466H-030	40.0 cm - Push-to-open function	466H-040	50.0 cm - Push-to-open function	466H-050	60.0 cm - Push-to-open function	466H-060	80.0 cm - Push-to-open function	466H-080
Front in MDF, White NCS 0500-N	380H-xxx-01																														
Lacquered Alu. white RAL 9003	385H-xxx-01																														
Lacquered Alu. anthracite RAL 9004	385H-xxx-07																														
Anodised aluminium	385H-xxx-06																														
30.0 cm	465H-030																														
40.0 cm	465H-040																														
50.0 cm	465H-050																														
60.0 cm	465H-060																														
80.0 cm	465H-080																														
30.0 cm - Push-to-open function	466H-030																														
40.0 cm - Push-to-open function	466H-040																														
50.0 cm - Push-to-open function	466H-050																														
60.0 cm - Push-to-open function	466H-060																														
80.0 cm - Push-to-open function	466H-080																														

# Ergosteel Trendline Accessible Sinks



## **Accessibility meets style**

The shallow sink bowl with a 120mm depth allows users in a seated or standing position to use the sinks at a comfortable height.

As each individual users' needs are different, so too are our handmade range of custom sinks. All our sinks are designed to simplify everyday tasks.

The sinks are made from 1.2mm stainless steel with a low depth strainer waste and off-set waste.

All Ergosteel sinks feature a unique off-set waste designed to work with a rise and fall worktop system.

All our sinks are insulated to protect the users' knees and legs, in compliance with UK Building Regulations.





## Shallow depth of the sink bowls

Shallower depth of the sink bowls (120mm) optimises the comfort of the user when in a seated position.



## Heat Insulation

The underside of an exposed sink with shallow depth must be insulated to avoid burns.

The heat insulation pad is made of flame-resistant, 4mm cellular rubber with a temperature-resistant acrylic glue.



## Rear positioned strainer waste and water trap

To give added legroom under the sink, the specially designed waste trap is positioned towards the rear of the sink.



## Flexible drain connection

All sinks are supplied with a flexible drain connection containing a strainer waste, basket and telescopic waste outlet arm(s) with a flexible drainage hose.

The flexible drainage hose can be extended from 200 to 520mm to work with height adjustable work tops. The flexible hose also allows for easy installation on fixed, reduced height worktops.

External pipe diameter drain pipe: 50 mm  
Material: PP (Polypropylene)







**SINCE 1870**

**GRANBERG**

# Trendline - Stainless Steel Kitchen Sinks



## Features and benefits

- Quality hand-made 1.2 mm stainless steel sinks with a brushed surface and profiled base to waste improving water flow.
- Unique waste, the flexible hose is adapted for height adjustable worktop systems
- Including heat insulation for protecting the users' knees and legs when in a seated position
- The sink bowl outlet with a strainer waste is located at the rear of the sink bowl; maximizing the available space for a seated user
- Overflow protection on all models
- All models are available in a coloured PVD coating

## Mounting methods



Inset



Under mounted



Under gluing



Planar gluing



- All sinks are supplied with a basket waste, overflow drain and a water trap with a flexible hose



40

**Trendline EST-330**  
**330 x 400**

Art. no. 618EST-330  
For cabinet size 400 mm  
Depth of sink bowl 120 mm  
Inside corner radius 20 mm  
Material thickness 1,2 mm  
Inner dimensions 330 x 400 mm  
Outer dimensions 370 x 440 mm

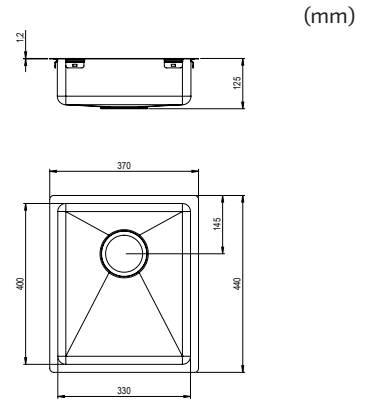

60

**Trendline EST-500**  
**500 x 400**

Art. no. 618EST-500  
For cabinet size 600 mm  
Depth of sink bowl 120 mm  
Inside corner radius 20 mm  
Material thickness 1,2 mm  
Inner dimensions 500 x 400 mm  
Outer dimensions 540 x 440 mm

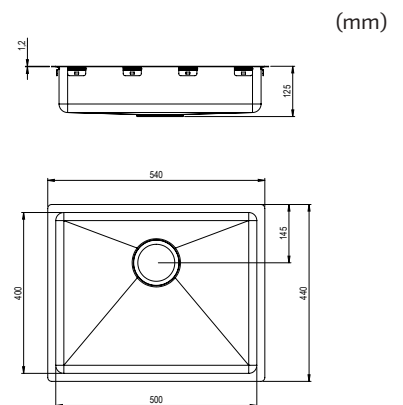

60

**Trendline EST-53KH**  
**200 / 330 x 400**

Art. no. 618EST-53KH  
For cabinet size 600 mm  
Depth of sink bowl 120 mm  
Inside corner radius 20 mm  
Material thickness 1,2 mm  
Inner dimensions 200 / 330 x 400 mm  
Outer dimensions 578 x 440 mm

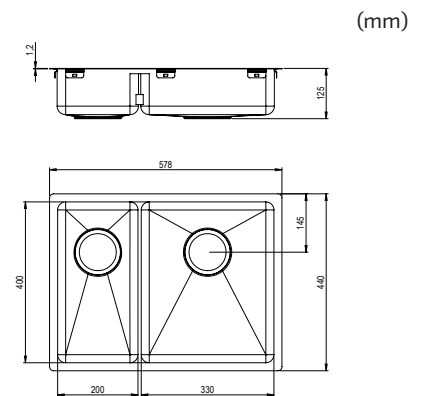

80

**Trendline EST-80K**  
**340 / 340 x 400**

Art. no. 618EST-80K  
For cabinet size 800 mm  
Depth of sink bowl 120 mm  
Inside corner radius 20 mm  
Material thickness 1,2 mm  
Inner dimensions 340 / 340 x 400 mm  
Outer dimensions 728 x 440 mm

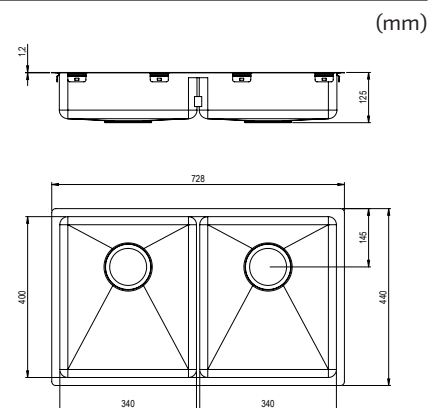



# Trendline - PVD Sinks



Our colored sinks are treated with a PVD technology, (Physical Vapor Deposition), an advanced form of surface treatment for stainless steel. The treatment provides a durable and attractive surface.

PVD treatment is an advanced vacuum process that retains the basic material's surface structure and gives the feeling that the material is dyed through and not varnished.

## Mounting methods

-  Inset
-  Under mounted
-  Under gluing
-  Planar gluing

- All sinks are supplied with a basket waste, overflow drain and a water trap with a flexible hose



40

**Trendline EST-330 - Black  
330 x 400**

Art. no. 618EST-330-02  
 For cabinet size 400 mm  
 Depth of sink bowl 120 mm  
 Inside corner radius 20 mm  
 Material thickness 1,2 mm  
 Inner dimensions 330 x 400 mm  
 Outer dimensions 370 x 440 mm

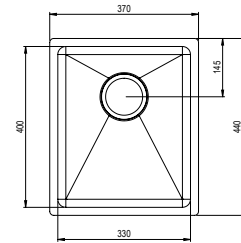
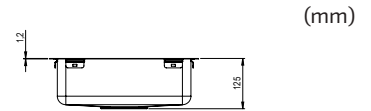

60

**Trendline EST-500 - Black  
500 x 400**

Art. no. 618EST-500-02  
 For cabinet size 600 mm  
 Depth of sink bowl 120 mm  
 Inside corner radius 20 mm  
 Material thickness 1,2 mm  
 Inner dimensions 500 x 400 mm  
 Outer dimensions 540 x 440 mm

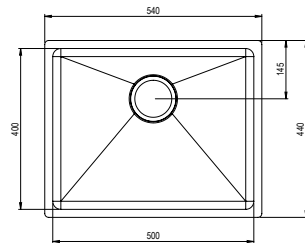
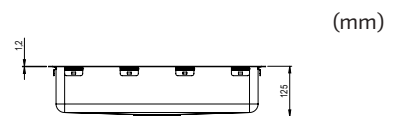

60

**Trendline EST-53KH - Black  
200 / 330 x 400**

Art.nr. 618EST-53KH-02  
 For cabinet size 600 mm  
 Depth of sink bowl 120 mm  
 Inside corner radius 20 mm  
 Material thickness 1,2 mm  
 Inner dimensions 200 / 330 x 400 mm  
 Outer dimensions 578 x 440 mm

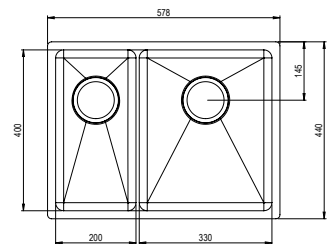
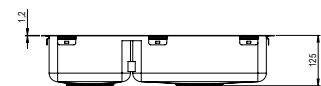

80

**Trendline EST-80K - Black  
340 / 340 x 400**

Art. no. 618EST-80K-02  
 For cabinet size 800 mm  
 Depth of sink bowl 120 mm  
 Inside corner radius 20 mm  
 Material thickness 1,2 mm  
 Inner dimensions 340 / 340 x 400 mm  
 Outer dimensions 728 x 440 mm

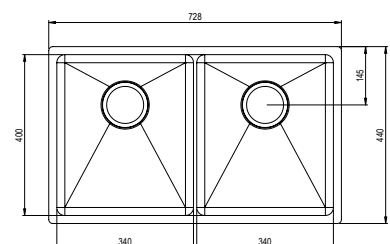
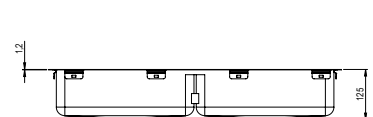

- All sinks are supplied with a basket waste, overflow drain and a water trap with a flexible hose



40

**Trendline EST-330 - Gold**  
**330 x 400**

Art. no. 618EST-330-03  
 For cabinet size 400 mm  
 Depth of sink bowl 120 mm  
 Inside corner radius 20 mm  
 Material thickness 1,2 mm  
 Inner dimensions 330 x 400 mm  
 Outer dimensions 370 x 440 mm

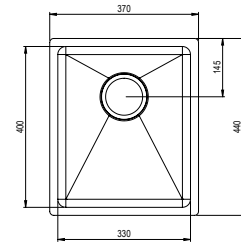
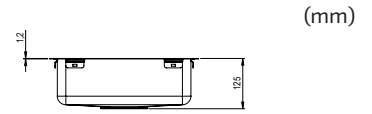

60

**Trendline EST-500 - Gold**  
**500 x 400**

Art. no. 618EST-500-03  
 For cabinet size 600 mm  
 Depth of sink bowl 120 mm  
 Inside corner radius 20 mm  
 Material thickness 1,2 mm  
 Inner dimensions 500 x 400 mm  
 Outer dimensions 540 x 440 mm

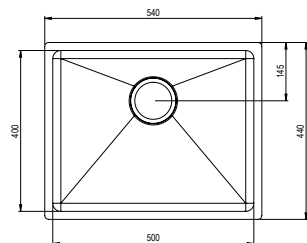
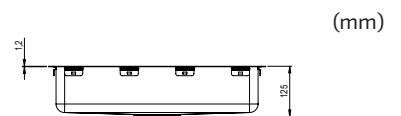

60

**Trendline EST-53KH - Gold**  
**200 / 330 x 400**

Art.nr. 618EST-53KH-03  
 For cabinet size 600 mm  
 Depth of sink bowl 120 mm  
 Inside corner radius 20 mm  
 Material thickness 1,2 mm  
 Inner dimensions 200 / 330 x 400 mm  
 Outer dimensions 578 x 440 mm

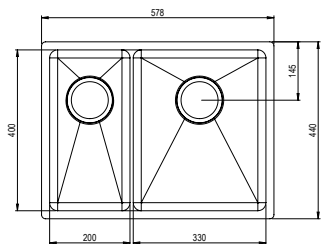
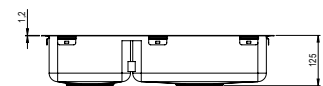

80

**Trendline EST-80K - Gold**  
**340 / 340 x 400**

Art. no. 618EST-80K-03  
 For cabinet size 800 mm  
 Depth of sink bowl 120 mm  
 Inside corner radius 20 mm  
 Material thickness 1,2 mm  
 Inner dimensions 340 / 340 x 400 mm  
 Outer dimensions 728 x 440 mm

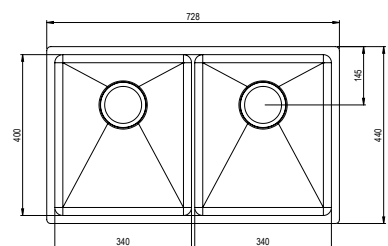
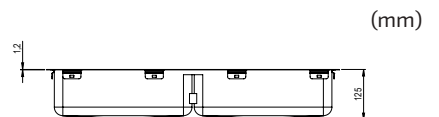



- All sinks are supplied with a basket waste, overflow drain and a water trap with a flexible hose



40

**Trendline EST-330 - Copper**  
**330 x 400**

Art. no. 618EST-330-04  
 For cabinet size 400 mm  
 Depth of sink bowl 120 mm  
 Inside corner radius 20 mm  
 Material thickness 1,2 mm  
 Inner dimensions 330 x 400 mm  
 Outer dimensions 370 x 440 mm

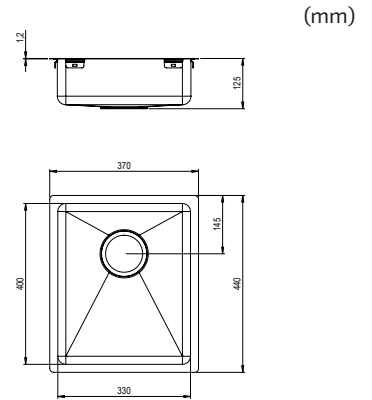

60

**Trendline EST-500 - Copper**  
**500 x 400**

Art. no. 618EST-500-04  
 For cabinet size 600 mm  
 Depth of sink bowl 120 mm  
 Inside corner radius 20 mm  
 Material thickness 1,2 mm  
 Inner dimensions 500 x 400 mm  
 Outer dimensions 540 x 440 mm

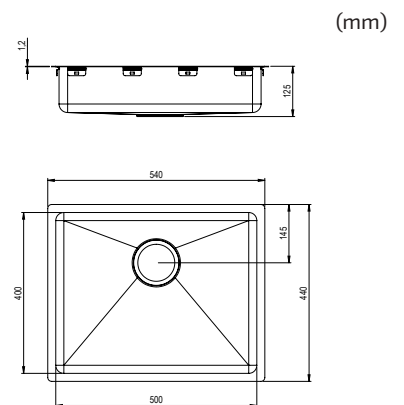

60

**Trendline EST-53KH - Copper**  
**200 / 330 x 400**

Art.nr. 618EST-53KH-04  
 For cabinet size 600 mm  
 Depth of sink bowl 120 mm  
 Inside corner radius 20 mm  
 Material thickness 1,2 mm  
 Inner dimensions 200 / 330 x 400 mm  
 Outer dimensions 578 x 440 mm

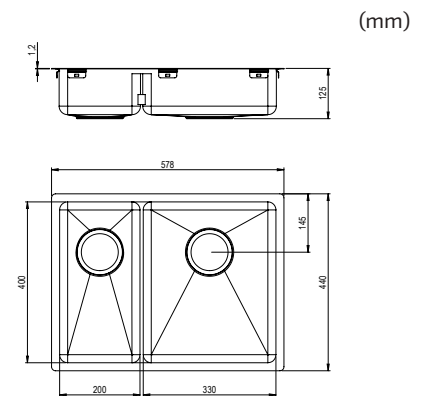

80

**Trendline EST-80K - Copper**  
**340 / 340 x 400**

Art. no. 618EST-80K-04  
 For cabinet size 800 mm  
 Depth of sink bowl 120 mm  
 Inside corner radius 20 mm  
 Material thickness 1,2 mm  
 Inner dimensions 340 / 340 x 400 mm  
 Outer dimensions 728 x 440 mm

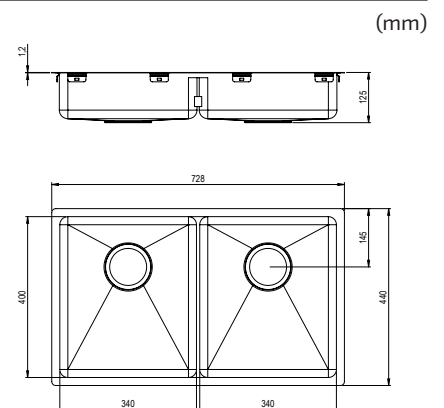

- All sinks are supplied with a basket waste, overflow drain and a water trap with a flexible hose



40

**Trendline EST-330 - Bronze**  
**330 x 400**

Art. no. 618EST-330-05  
 For cabinet size 400 mm  
 Depth of sink bowl 120 mm  
 Inside corner radius 20 mm  
 Material thickness 1,2 mm  
 Inner dimensions 330 x 400 mm  
 Outer dimensions 370 x 440 mm

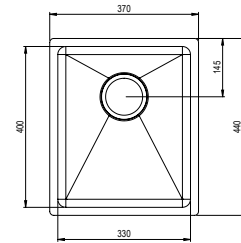
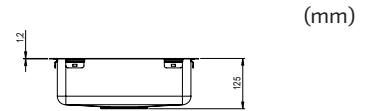

60

**Trendline EST-500 - Bronze**  
**500 x 400**

Art. no. 618EST-500-05  
 For cabinet size 600 mm  
 Depth of sink bowl 120 mm  
 Inside corner radius 20 mm  
 Material thickness 1,2 mm  
 Inner dimensions 500 x 400 mm  
 Outer dimensions 540 x 440 mm

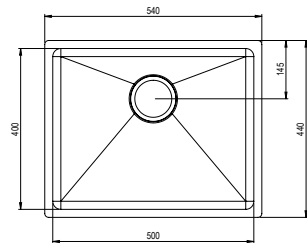
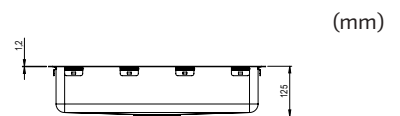

60

**Trendline EST-53KH - Bronze**  
**200 / 330 x 400**

Art.nr. 618EST-53KH-05  
 For cabinet size 600 mm  
 Depth of sink bowl 120 mm  
 Inside corner radius 20 mm  
 Material thickness 1,2 mm  
 Inner dimensions 200 / 330 x 400 mm  
 Outer dimensions 578 x 440 mm

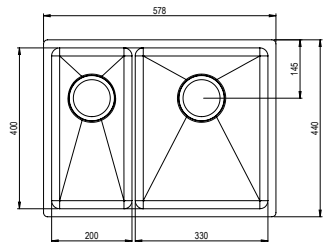
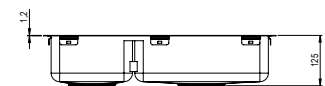

80

**Trendline EST-80K - Bronze**  
**340 / 340 x 400**

Art. no. 618EST-80K-05  
 For cabinet size 800 mm  
 Depth of sink bowl 120 mm  
 Inside corner radius 20 mm  
 Material thickness 1,2 mm  
 Inner dimensions 340 / 340 x 400 mm  
 Outer dimensions 728 x 440 mm

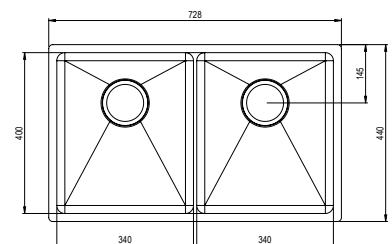
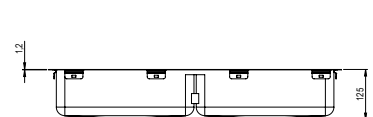

- All sinks are supplied with a basket waste, overflow drain and a water trap with a flexible hose



40

**Trendline EST-330 - Champagne  
330 x 400**

Art. no. 618EST-330-06  
 For cabinet size 400 mm  
 Depth of sink bowl 120 mm  
 Inside corner radius 20 mm  
 Material thickness 1,2 mm  
 Inner dimensions 330 x 400 mm  
 Outer dimensions 370 x 440 mm

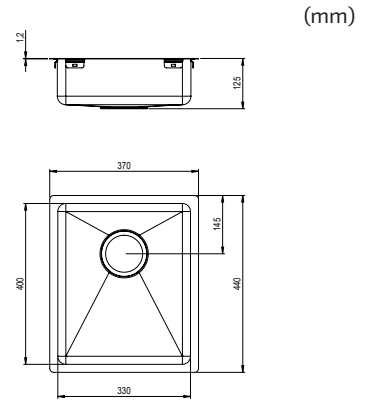

60

**Trendline EST-500 - Champagne  
500 x 400**

Art. no. 618EST-500-06  
 For cabinet size 600 mm  
 Depth of sink bowl 120 mm  
 Inside corner radius 20 mm  
 Material thickness 1,2 mm  
 Inner dimensions 500 x 400 mm  
 Outer dimensions 540 x 440 mm

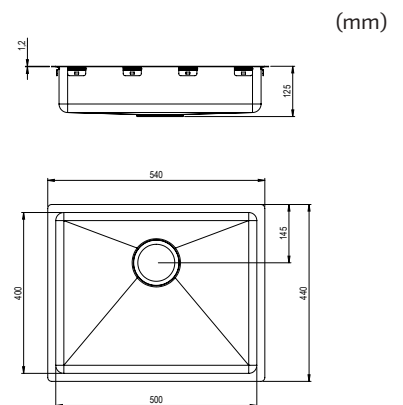

60

**Trendline EST-53KH - Champagne  
200 / 330 x 400**

Art.nr. 618EST-53KH-06  
 For cabinet size 600 mm  
 Depth of sink bowl 120 mm  
 Inside corner radius 20 mm  
 Material thickness 1,2 mm  
 Inner dimensions 200 / 330 x 400 mm  
 Outer dimensions 578 x 440 mm

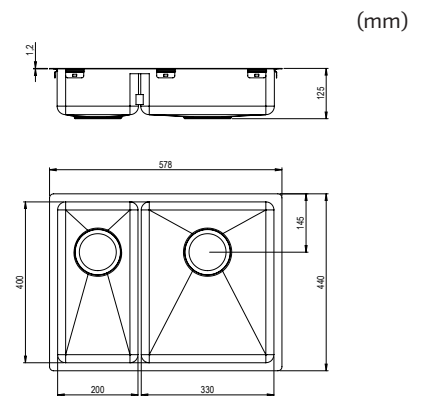

80

**Trendline EST-80K - Champagne  
340 / 340 x 400**

Art. no. 618EST-80K-06  
 For cabinet size 800 mm  
 Depth of sink bowl 120 mm  
 Inside corner radius 20 mm  
 Material thickness 1,2 mm  
 Inner dimensions 340 / 340 x 400 mm  
 Outer dimensions 728 x 440 mm

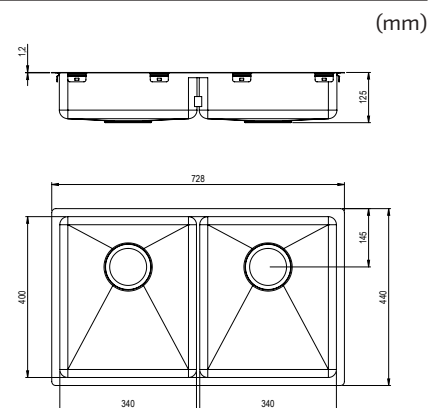



Stainless steel



Black



Gold



Copper



Bronze



Champagne

**Small rinsing tray**

The rinse bowl is durable, hygienic, versatile and made of high-quality stainless steel. The bottom is perforated where the water easily flows through so that you can easily rinse off your fruit, vegetables and dishes.

The deep design prevents unnecessary water spillage. You can also use the rinse bowl for thawing frozen food or as an extra work surface.

Dimensions: 200 x 430 x 70 mm (WxDxH)  
Fits all models

Small rinsing tray, Stainless steel	618-050
Small rinsing tray, Black	618-050-02
Small rinsing tray, Gold	618-050-03
Small rinsing tray, Copper	618-050-04
Small rinsing tray, Bronze	618-050-05
Small rinsing tray, Champagne	618-050-06



Stainless steel



Gold

**Large rinsing tray - for EST-500**

The tray is placed above the sink and provides an extra work surface for rinsing fruit and vegetables, thawing frozen goods or allowing washed plates and cutlery to drain. Made in robust, perforated stainless steel that is both hygienic and durable.

Dimensions: 355 x 440 mm (WxD)  
Fits EST-500 only

Large rinsing tray, Stainless steel	618-051
Large rinsing tray, Gold	618-051-03



Stainless steel



Gold

**Drying board - for EST-500**

The drying board is placed on the sink to allow the user to dry their dishes or thaw frozen food. Made of robust stainless steel that is both hygienic and durable.

Dimensions: 355 x 440 mm (WxD)  
Fits EST-500 only

Drying board, Stainless steel	618-052
Drying board, Gold	618-052-03



**Chopping board**

Swedish-made chopping board in oak. The chopping board has a milled chamfer on the underside to get a perfect fit for the sink bowl.

Dimensions: 310 x 420 mm (WxD)  
Fits all models

Chopping board, Oak	618-053
---------------------	---------



**Single rotary valve for sink bowl**

With the rotary waste valve, the drain is opened and closed using a button that should be recessed into the surface of the sink / work surface or fascia front.

Only suitable for single bowl configurations  
Maximum thickness (A): 45 mm  
Height (B): 80 mm  
Length of control cable: 560 mm

	618-060
--	---------





**SINCE 1870**

**GRANBERG**

# Ergosteel

Sinks and mixer taps

The sinks in the Ergosteel series all have shallow sink bowls and are suitable for use in a sitting position.

Our mixer taps are suitable for shallow sink bowls and have a long ergonomic lever.





## Inset sinks



Our inset sinks are either undermounted to the top board or inset from above. The inset sinks are manufactured in smooth stainless steel.



### Inset

A hole is sawn in the worktop and the inset sink is put in position from above. The inset sink is then fastened underneath with fittings while the outer edge lies on top of the board. This method is suitable for all types of worktop materials except natural stone. The hole is made on the spot by a fitter.



### Undermounted

A hole with an edge is milled out in the worktop from below. The inset sink is then glued on from underneath. The thickness of the visible material above the sink varies depending on whether this is done in laminate, wood or acrylic stone. Supplied assembled from the factory.



*The inset sinks are equipped with shallow sink bowls, adapted for sitting work.*



*The sink bowls are available in different sizes and combinations.*

## Sit-on sinks



Our Sit-on sinks are made of 1.0 mm, smooth stainless steel sheet. There is a raised ledge around the entire sink to prevent water from flowing over the edge.

Sit-on sinks units are adapted to our height-adjustable bench systems and thus provide a 15 mm space on the wall side for splash protection.

The width of the sinks is 10 mm shorter than standard to provide a 5 mm gap on each side of the height-adjustable units to the adjacent cabinet or wall.



*All sinks are equipped with shallow sink bowls, adapted for sitting work.*

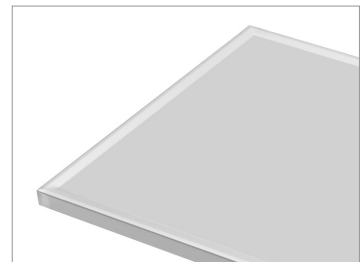

*The raised ledge effectively stops water from flowing over the edge.*

**Inset sink - Granberg ERGOSTEEL ES10**



**Inset sink  
Granberg ES10 - 44.1 cm**

- For cabinet size: 400 mm
- Height of the sink bowls: 120 mm
- Outer dimensions: 441 x 496 mm
- Plate thickness: 0.8 mm, brushed stainless steel
- Mounting: Inset or undermounted
- Heat insulation pad at the underside
- Incl. basket valve and water lock with flexible drain hose

618ES10-044

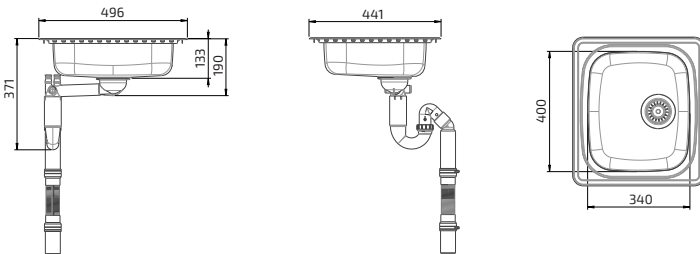

**Inset sink - Granberg ERGOSTEEL ES11**



**Inset sink  
Granberg ES11 - 49.6 cm**

- For cabinet size: 500 mm
- Height of the sink bowls: 120 mm
- Outer dimensions: 496 x 500 mm
- Plate thickness: 0.8 mm, brushed stainless steel
- Mounting: Inset or undermounted
- Heat insulation pad at the underside
- Incl. basket valve and water lock with flexible drain hose

618ES11-050

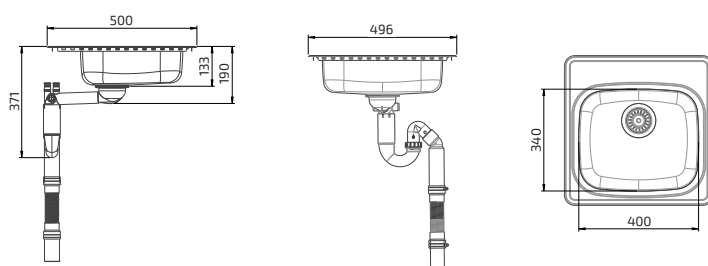



**Inset sink - Granberg ERGOSTEEL ES15**



**Inset sink  
Granberg ES15 - 76.6 cm**

- For cabinet size: 400 mm
- Height of the sink bowls: 120 mm
- Outer dimensions: 766 x 496 mm
- Plate thickness: 0.8 mm, brushed stainless steel
- Mounting: Inset or undermounted
- Heat insulation pad at the underside
- Incl. basket valve and water lock with flexible drain hose
- Reversible, for right or left

618ES15-077

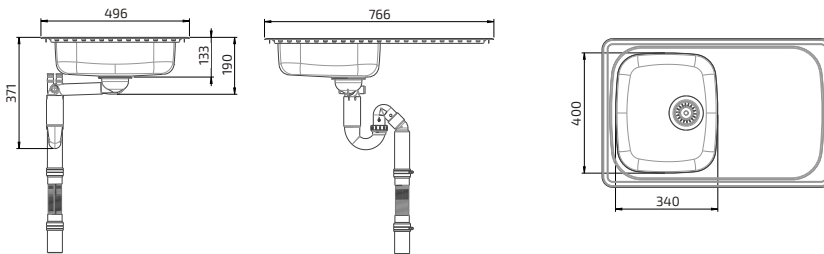

**Inset sink - Granberg ERGOSTEEL ES20**



**Inset sink  
Granberg ES20 - 61.6 cm**

- For cabinet size: 600 mm
- Height of the sink bowls: 120 mm
- Outer dimensions: 616 x 496 mm
- Plate thickness: 0.8 mm, brushed stainless steel
- For inset fitting or undermounting
- Heat insulation pad at the underside
- Incl. basket valve and water lock with flexible drain hose
- Reversible, for right or left

618ES20-062

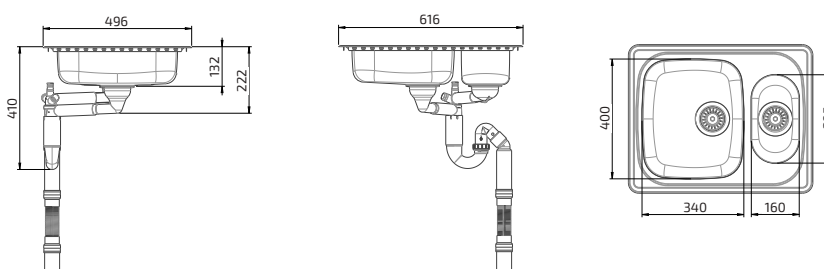

**Inset sink - Granberg ERGOSTEEL ES25**



**Inset sink  
Granberg ES25 - 97.1 cm**

- For cabinet size: 600 mm
- Height of the sink bowls: 120 mm
- Outer dimensions: 971 x 496 mm
- Plate thickness: 0.8 mm, brushed stainless steel
- Mounting: Inset or undermounted
- Heat insulation pad at the underside
- Incl. basket valve and water lock with flexible drain hose
- Reversible, for right or left

618ES25-097

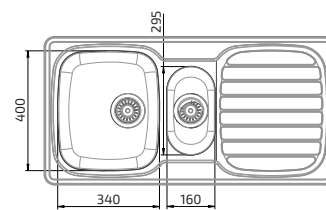
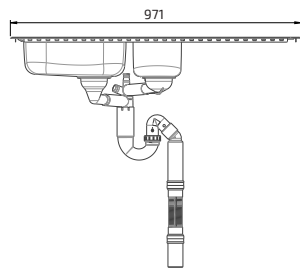
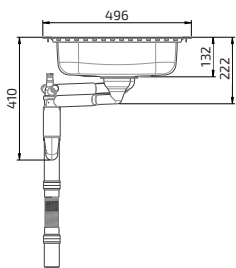

**Inset sink - Granberg ERGOSTEEL ES30**



**Inset sink  
Granberg ES30 - 76.6 cm**

- For cabinet size: 800 mm
- Height of the sink bowls: 120 mm
- Outer dimensions: 766 x 496 mm
- Plate thickness: 0.8 mm, brushed stainless steel
- Mounting: Inset or undermounted
- Heat insulation pad at the underside
- Incl. basket valve and water lock with flexible drain hose
- Reversible, for right or left

618ES30-077

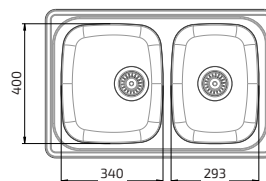
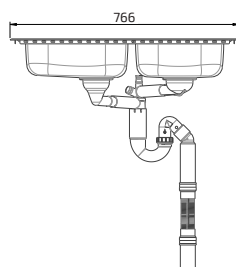
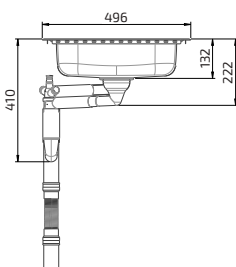

**Inset sink - Granberg ERGOSTEEL ES35**



**Inset sink  
Granberg ES35 - 120.6 cm**

- For cabinet size: 800 mm
- Height of the sink bowls: 120 mm
- Outer dimensions: 1206 x 496 mm
- Plate thickness: 0.8 mm, brushed stainless steel
- Mounting: Inset or undermounted
- Heat insulation pad at the underside
- Incl. basket valve and water lock with flexible drain hose
- Reversible, for right or left

618ES35-121

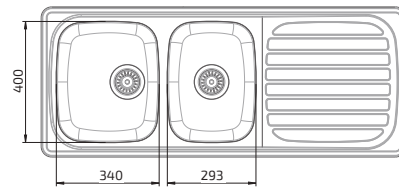
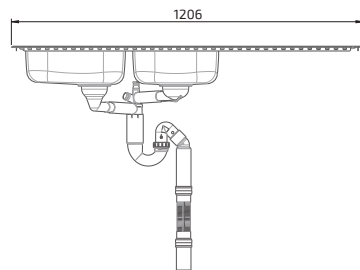
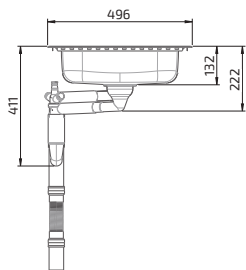

Sit-on sink with 1 sink bowl - Granberg ERGOSTEEL ESF

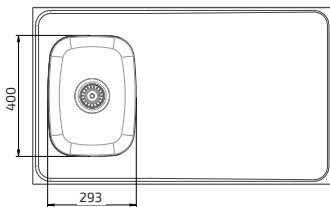
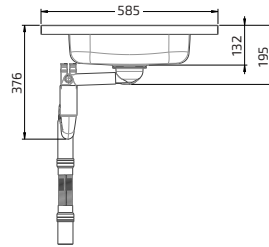
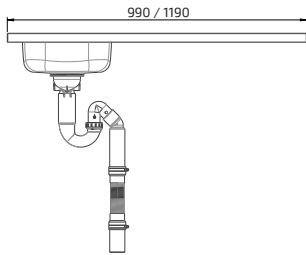

Sit-on sink with 1 sink bowl  
Granberg ESF

- For cabinet size: 400 mm
- Height of the sink bowl: 120 mm
- Depth: 585 mm\*
- Edge height: 30 mm
- Plate thickness: 1 mm smooth stainless steel plate on an underside of fully-glued MDF board
- Heat insulation pad at the underside
- Incl. basket valve and water lock with flexible drain hose
- Reversible, for right or left

\* Adapted to our height-adjustable bench systems and thus provide a 15-mm space on the wall side for splash protection.

The width of our sinks is 10 mm shorter than standard to provide a 5-mm gap on each side of the height-adjustable units to the adjacent cabinet or wall.

Sit-on sink with 1 sink bowl, 99 cm - Granberg ESF	617ESF-099
Sit-on sink with 1 sink bowl, 119 cm - Granberg ESF	617ESF-119

Sit-on sink with 2 sink bowls - Granberg ERGOSTEEL ESG

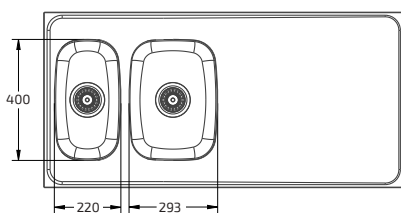
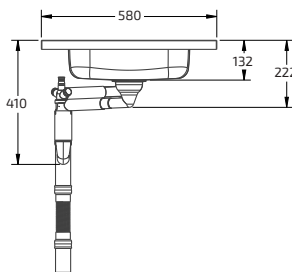
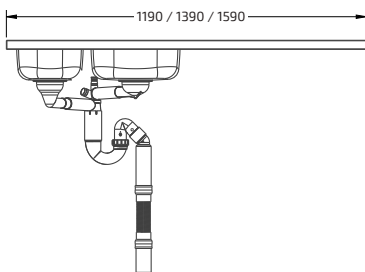

Sit-on sink with 2 sink bowls  
Granberg ESG

- For cabinet size: 600 mm
- Height of the sink bowls: 120 mm
- Depth: 585 mm\*
- Edge height: 30 mm
- Plate thickness: 1 mm smooth stainless steel plate on an underside of fully-glued MDF board
- Heat insulation pad at the underside
- Incl. basket valve and water lock with flexible drain hose
- Reversible, for right or left

\* Adapted to our height-adjustable bench systems and thus provide a 15-mm space on the wall side for splash protection.

The width of our sinks is 10 mm shorter than standard to provide a 5-mm gap on each side of the height-adjustable units to the adjacent cabinet or wall.

Sit-on sink with 2 sink bowls, 119 cm - Granberg ESG	617ESG-119
Sit-on sink with 2 sink bowls, 139 cm - Granberg ESG	617ESG-139
Sit-on sink with 2 sink bowls, 159 cm - Granberg ESG	617ESG-159



Sit-on sink with 2 sink bowls - Granberg ERGOSTEEL ESH

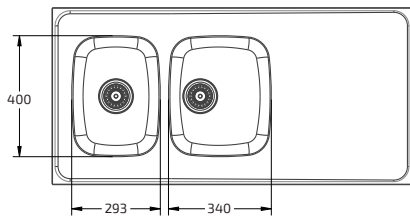
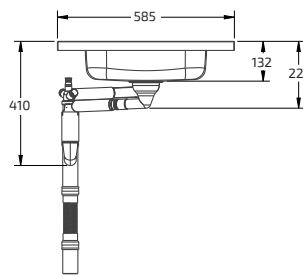
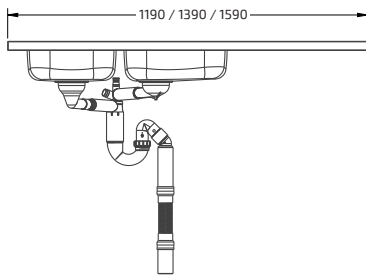

Sit-on sink with 2 sink bowls  
Granberg ESH

- For cabinet size: 800 mm
- Height of the sink bowls: 120 mm
- Depth: 585 mm\*
- Edge height: 30 mm
- Plate thickness: 1 mm smooth stainless steel plate on an underside of fully-glued MDF board
- Heat insulation pad at the underside
- Incl. basket valve and water lock with flexible drain hose
- Reversible, for right or left

\* Adapted to our height-adjustable bench systems and thus provide a 15-mm space on the wall side for splash protection.

The width of our sinks is 10 mm shorter than standard to provide a 5-mm gap on each side of the height-adjustable units to the adjacent cabinet or wall.

Sit-on sink with 2 sink bowls, 119 cm - Granberg ESH	617ESH-119
Sit-on sink with 2 sink bowls, 139 cm - Granberg ESH	617ESH-139
Sit-on sink with 2 sink bowls, 159 cm - Granberg ESH	617ESH-159

Sit-on sink with 1 sink bowl and hole for hob Granberg ESFS



Hob not included

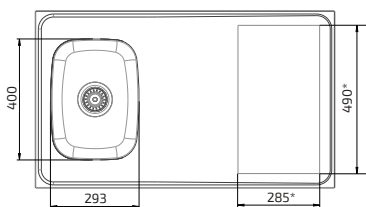
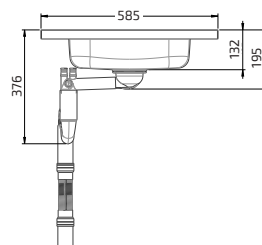
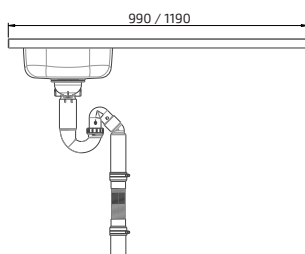

\* Can be customised



Sit-on sink with 1 sink bowl and hole for hob  
Granberg ESFS

- For cabinet size: 400 mm
- Height of the sink bowl: 120 mm
- Depth: 585 mm\*
- Edge height: 30 mm
- Plate thickness: 1 mm smooth stainless steel plate on an underside of fully-glued MDF board
- Incl. basket valve and water lock with flexible drain hose
- Reversible, for right or left

\* Adapted to our height-adjustable bench systems and thus provide a 15-mm space on the wall side for splash protection.

The width of our sinks is 10 mm shorter than standard to provide a 5-mm gap on each side of the height-adjustable units to the adjacent cabinet or wall.

Sit-on sink with 1 sink bowl and hole for hob 99 cm - Granberg ESFS	617ESFS-099
Sit-on sink with 1 sink bowl and hole for hob 119 cm - Granberg ESFS	617ESFS-119

Sit-on sink - 2 sink bowls and hole for hob - Granberg ERGOSTEEL ESHS



Hob not included



Sit-on sink - 2 sink bowls and hole for hob Granberg ESHS

- For cabinet size: 800 mm
- Height of the sink bowls: 120 mm
- Depth: 585 mm\*
- Edge height: 30 mm
- Plate thickness: 1 mm smooth stainless steel plate on an underside of fully-glued MDF board
- Heat insulation pad at the underside
- Incl. basket valve and water lock with flexible drain hose
- Reversible, for right or left

\* Adapted to our height-adjustable bench systems and thus provide a 15-mm space on the wall side for splash protection.

The width of our sinks is 10 mm shorter than standard to provide a 5-mm gap on each side of the height-adjustable units to the adjacent cabinet or wall.

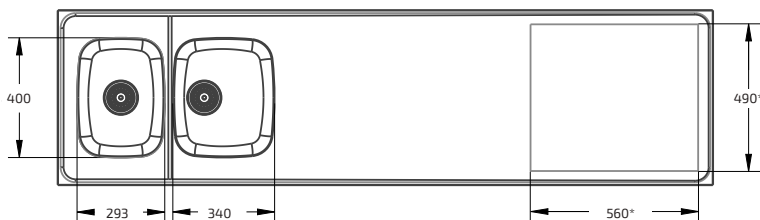
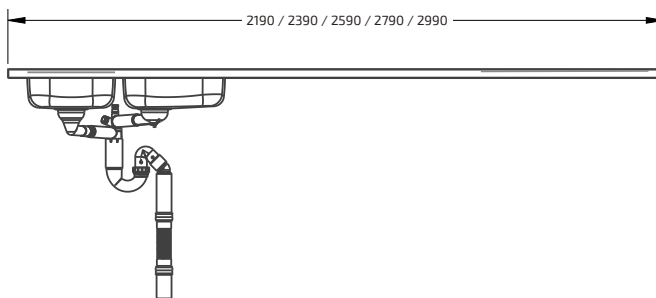
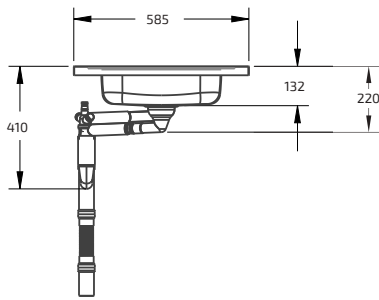

Sit-on sink with 2 sink bowls and hole for hob 219 cm - Granberg ESHS	617ESHs-219
Sit-on sink with 2 sink bowls and hole for hob 239 cm - Granberg ESHS	617ESHs-239
Sit-on sink with 2 sink bowls and hole for hob 259 cm - Granberg ESHS	617ESHs-259
Sit-on sink with 2 sink bowls and hole for hob 279 cm - Granberg ESHS	617ESHs-279
Sit-on sink with 2 sink bowls and hole for hob 289 cm - Granberg ESHS	617ESHs-289



**Chopping board for sink bowl 293x400 mm**

Chopping board placed over sink bowl to provide food preparation surface/cutting board.

Suitable for sink bowls sized 293x400 mm.

Made from cultivated teak

618-025



**Chopping board for sink bowl 340x400 mm**

Chopping board placed over sink bowl to provide food preparation surface/cutting board.

Fits sink bowls sized 340x400 mm.

Made from cultivated teak

618-026



**Wire basket for sink bowl 340x400 mm**

Wire basket that can be used as a drainer. Fits sink bowls sized 340x400 mm.

Made of white plastic-coated wire.

618-024



**Cutlery box for rinsing bowl 160x295 mm**

Cutlery box that fits rinsing bowl sized 160x295 mm.

Made from white plastic.

618-023



**Rinsing bowl for sink bowl 160x295 mm**

Rinsing bowl that fits sink bowls sized 160x295 mm.

Made from white plastic.

618-027



**Washing-up liquid dispenser**

Pump for washing-up liquid.

Requires hole to be made in sink.

618-022



**Strainer package for sinks**

The package contains:  
1 rubber plug  
2 strainers  
2 spacers

618-020

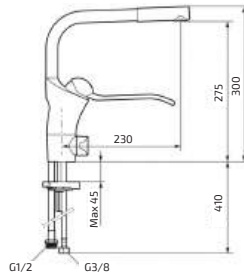

**Granberg's mixer tap**

Incl. dishwasher closure  
Length of lever, 190 mm  
Height of spout, 300 mm

60210

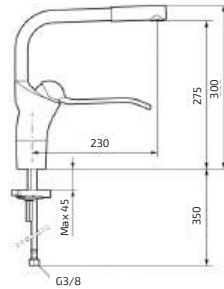

**Granberg's mixer tap**

Excl. dishwasher closer  
Length of lever, 190 mm  
Height of spout, 300 mm

60211



**Flexible water hoses 2-pack**

In combination with the worktop lift, water hoses provide flexible water connection.

Length, 500 mm, connection R15 (1/2")

61800



**Flexible drain hose**

In combination with the worktop lift, drain hoses provide flexible drain connection.

*The hose is included with our sinks.*

Drain hose:  
Length, 200 - 650 mm  
Diameter at connection, 50 mm

61801



## Mini-cabinet on wheels



Integrated grip handle makes it easy to move the mini cabinet on wheels if necessary. Choose between waste sorting or saucepan storage. Both models have a large drawer that is pulled out to access the contents. Underneath the drawer, there is a support wheel that prevents the cabinet from tipping forward.



### Mini cabinet on wheels with drawer and inner drawer, fully extendable with soft-close

The cabinet is opened by pulling out the drawer.

Width: 400 mm  
Height: 574 mm  
Depth incl. grip handle: 495 mm

Top board in white compact laminate with integrated grip handle.

Frame in white melamine.  
White-lacquered door (NCS 0500-N)

770-040-01



### Mini cabinet on wheels with waste sorting and inner drawer, fully extendable with soft-close

The cabinet is opened by pulling out the drawer.  
The bottom with the waste bins is included.

Included bins:  
1 pc 11 litre 1 pc 17 litre

Width: 400 mm  
Height: 574 mm  
Depth incl. grip handle: 495 mm

Top board in white compact laminate with integrated grip handle.

Frame in white melamine.  
White-lacquered door (NCS 0500-N)

771-040-01

# UNILIFT 870

Kitchen appliance lift

UNILIFT raises a board upwards and outwards from the bottom of a cabinet or tall cabinet. A kitchen appliance, microwave oven or other household machinery can be placed on the board.

With a simple press of a button, the height of the board is adjusted to optimal working height.



## Functions and advantages

- Raises heavy household appliances to a comfortable height
- The movement can be stopped at any height.
- Easily mounted on the bottom of a cabinet or tall cabinet.
- Can be mounted in new or existing cabinets

## Standard equipment

- Wired hand control
- Work surface board

## Specifications

<b>Mounting</b>	In a bench cabinet or high cabinet
<b>Height adjustment</b>	Motorised, steplessly adjustable 745 mm upwards and 500 mm outwards from the cabinet
<b>Speed</b>	37 mm / sec.
<b>Manoeuvring</b>	Wired hand control or radio control
<b>Electricity connection</b>	Plug for 230 V, Max 2.5 A
<b>Maximum load on board</b>	20 kg
<b>Fits cabinets with width</b>	400 - 600 mm
<b>Material specifications</b>	Powder-lacquered sheet metal parts (alu-grey RAL 9006)
<b>Guarantee</b>	2 years
	CE

## Measurement data

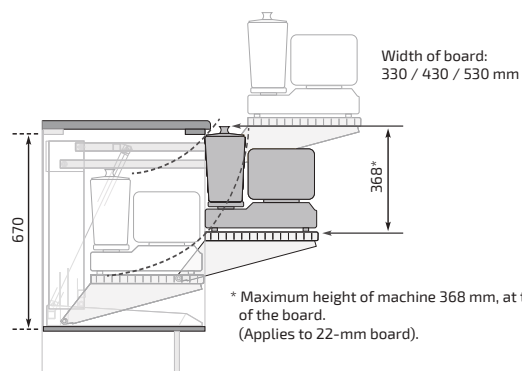
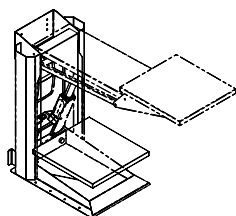
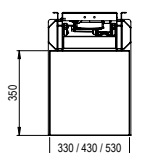
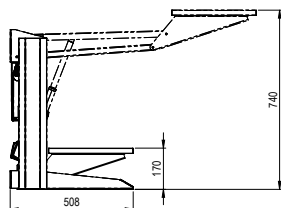
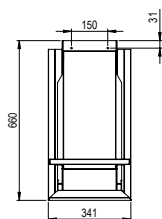

(mm)



**UNILIFT 870 - Lifting unit**

Width of lift: 340 mm

870-034



**Worktop**

The board is made of white laminate with edging of ABS plastic.

Depth: 350 mm

Thickness: 22 mm

Width: 33.0 cm  
(For cabinet width 40.0 cm)

891-033

Width: 43.0 cm  
(For cabinet width 50.0 cm)

891-043

Width: 53.0 cm  
(For cabinet width 50.0 cm)

891-053



**Radio control - Hand control**

Dimensions: 38 x 110 x 10 mm

For one lift

61385



**Hand control**

Wired hand control.

Hanging fittings included.

Dimensions: 147 x 56 x 23 mm

61305

# Contact

## **Granberg Interior AB**

Importgatan 30

SE-602 28 Norrköping

SWEDEN

Tel: +46(0)11-19 77 50

Email: [info@granberg.se](mailto:info@granberg.se)

Internet: [www.granberg.se](http://www.granberg.se)

## **Granberg United Kingdom**

Bellamy House Winton Road

Petersfield, Hampshire GU32 3HA

United Kingdom

Tel: +44 (0)800 0470 027

Email: [info@granberg-uk.co.uk](mailto:info@granberg-uk.co.uk)

Internet: [www.granberg-uk.co.uk](http://www.granberg-uk.co.uk)





**SINCE 1870**

**GRANBERG**

Granbergs reserves the right to make changes in design and workmanship.  
Colours may be different from those in the catalogue. Granbergs reserves the right to make changes in the range.  
Design and production of catalogue: Granberg Interior AB



**SINCE 1870**

**GRANBERG**





White upper wall cabinet with a flat front panel.

Open shelving unit with a wooden backsplash, holding a stack of white plates and a glass.

White upper wall cabinet with a flat front panel.

White floating shelf with a wooden backsplash, holding a stack of white plates.

White floating shelf with a wooden backsplash, holding a glass.

White lower wall cabinet with a flat front panel, featuring a sink and a copper faucet.

White floating shelf with a wooden backsplash, holding a glass.

White kitchen island with a curved edge, featuring a sink and a copper faucet.

White lower wall cabinet with a flat front panel, featuring a sink and a copper faucet.



**GRANBERG**

**GRANBERG INTERIOR AB**  
Importgatan 30  
602 28 Norrköping  
Sweden  
Tel: +46 (0)11-19 77 50  
Email: [info@granberg.se](mailto:info@granberg.se)  
Internet: [www.granberg.se](http://www.granberg.se)

**GRANBERG UNITED KINGDOM**  
Bellamy House Winton Road  
Petersfield, Hampshire GU32 3HA  
United Kingdom  
Tel: +44 (0)800 0470 027  
Email: [info@granberg-uk.co.uk](mailto:info@granberg-uk.co.uk)  
Internet: [www.granberg-uk.co.uk](http://www.granberg-uk.co.uk)

SINCE 1870

